



US18-PL-5-N03 Ultrasonic Sensors

Miniature Ultrasonic Sensors with TEACH-Mode Programming

- Fast, easy-to-use TEACH-Mode programming; no potentiometer adjustments
- Ultra-compact housing
- One discrete output: NPN or PNP, depending on model
- Two bi-colored status LEDs
- 4-pin Euro-style connector
- Wide operating range of -20° to +60° C
- Temperature compensation
- Configurable for normally open or normally closed operation
- Fast response time (15 milliseconds)

Models	Sensing Range	TEACH Option	Conn.	Supply Voltage	Output
US18-PL-5-N03-NH	50 mm to 500 mm	Integral push button or remote TEACH	4-pin Euro-style connector	12-30 VDC	NPN
US18-PL-5-N03-PH					PNP

US18 Effective Beam Pattern (Typical)

US18 Maximum Target Rotation Angle

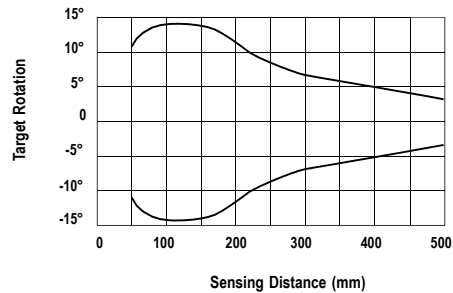
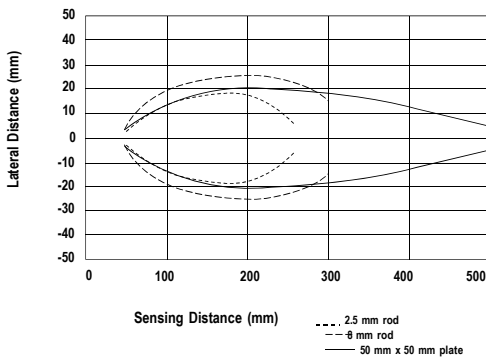

WARNING: Not To Be Used for Personnel Protection

Never use this device as a sensing device for personnel protection. Doing so could lead to serious injury or death. This device does not include the self-checking redundant circuitry necessary to allow its use in personnel safety applications. A sensor failure or malfunction can cause either an energized or de-energized sensor output condition.

PRINCIPLES OF OPERATION

Ultrasonic sensors emit one or multiple pulses of ultrasonic energy, which travel through the air at the speed of sound. A portion of this energy reflects off the target and travels back to the sensor. The sensor measures the total time required for the energy to reach the target and return to the sensor. The distance to the object is then calculated using the following formula: $D = ct \div 2$

D = distance from the sensor to the target
c = speed of sound in air
t = transit time for the ultrasonic pulse

To improve accuracy, an ultrasonic sensor may average the results of several pulses before outputting a new value.

Temperature Effects

The speed of sound is dependent upon the composition, pressure and temperature of the gas in which it is traveling. For most ultrasonic applications, the composition and pressure of the gas are relatively fixed, while the temperature may fluctuate. In air, the speed of sound varies with temperature according to the following approximation:

In metric units: $C_{m/s} = 20 \sqrt{273 + T_C}$

In English units: $C_{ft/s} = 49 \sqrt{460 + T_F}$

$C_{m/s}$ = speed of sound in meters per second

$C_{ft/s}$ = speed of sound in feet per second

T_C = temperature in °C

T_F = temperature in °F

Temperature Compensation

Changes in air temperature affect the speed of sound, which in turn affects the distance reading measured by the sensor. An increase in air temperature shifts both sensing window limits closer to the sensor. Conversely, a decrease in air temperature shifts both limits farther away from the sensor. This shift is approximately 3.5% of the limit distance for a 20° C change in temperature. The US18 series ultrasonic sensors are temperature compensated. This reduces the error due to temperature by about 90%. The sensor will maintain its window limits to within 1.8% over the -20° to +60° C range.



NOTE:

- Exposure to direct sunlight can affect the sensor's ability to accurately compensate for changes in temperature.
- If the sensor is measuring across a temperature gradient, the compensation will be less effective.
- The temperature warmup drift upon power-up is less than 7% of the sensing distance.
 After 5 minutes, the apparent switchpoint will be within 0.6% of the actual position.
 After 25 minutes, the sensing position will be stable.

Sensor Programming

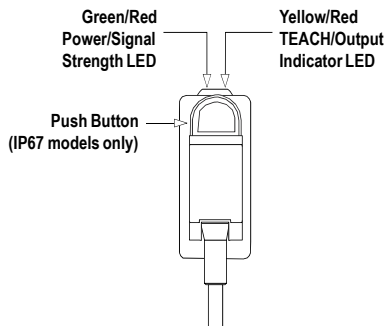

Two TEACH methods may be used to program the sensor:

- Teach individual minimum and maximum limits, or
- Use Auto-Window feature to center a sensing window around the taught position

The sensor may be programmed either via its push button, or via a remote switch.

Remote programming also may be used to disable the push button, preventing unauthorized personnel from adjusting the programming settings.

To access this feature, connect the white wire of the sensor to 0 VDC, with a remote programming switch between the sensor and the voltage.

Figure 1. Sensor Features

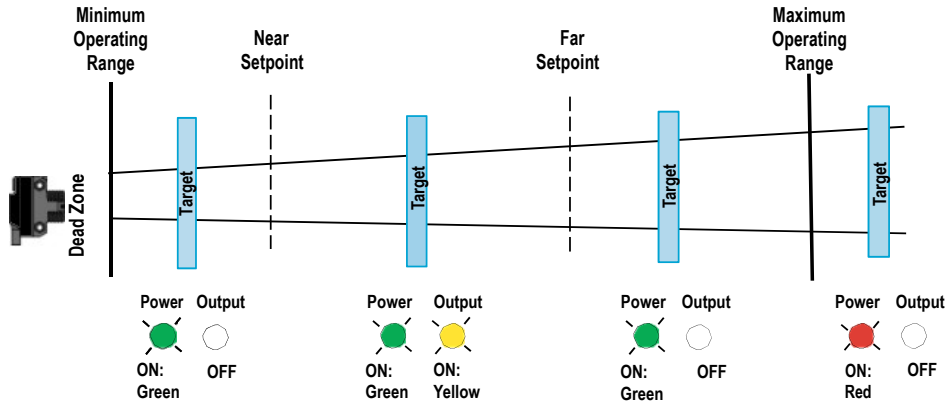

Figure 2. TEACH Interface

Status Indicators

Power ON/OFF LED	Indicates	Output/Teach LED	Indicates
OFF	Power is OFF	OFF	Target is outside window limits (normally open operation).
ON Red	Target is weak or outside sensing range.	Yellow	Target is within window limits (normally open operation).
ON Green	Sensor is operating normally, good target.	ON Red (solid)	In Teach Mode, waiting for first limit.
		ON Red (flashing)	In Teach Mode, waiting for second limit.

Teaching Minimum and Maximum Limits

General Notes on Programming

- The sensor returns to Run mode if the first TEACH condition is not registered within 120 seconds.
- After the first limit is taught, the sensor remains in Program mode until the TEACH sequence is finished.
- To exit Program mode without saving any changes, press and hold the programming push button for more than 2 seconds (before teaching the second limit).
The sensor reverts to the last saved limits.

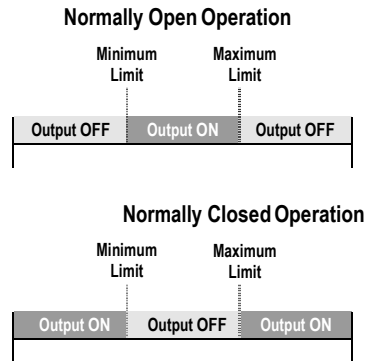







Figure 3. Teaching independent minimum and maximum limits

	Procedure		Result
	Push Button (0.04 sec ≤ Click ≤ 0.8 sec)	Remote Line (0.04 sec < T < 0.8 sec)	
Programming Mode	Press and hold push button 	No action required; sensor is ready for 1st limit teach	Output LED: ON Red Power LED: ON Green (good signal) or ON Red (no signal)
Teach First Limit	Position the target for the first limit	Position the target for the first limit	Power LED: Must be ON Green
	"Click" the push button 	Single-pulse the remote line 	TeachAccepted Output LED: Flashing Red TeachUnacceptable Output LED: ON Red
Teach Second Limit	Position the target for the second limit	Position the target for the second limit	Power LED: Must be ON Green
	"Click" the push button 	Single-pulse the remote line 	TeachAccepted Output LED: Yellow or OFF TeachUnacceptable Output LED: Flashing Red

Teaching Limits Using the Auto-Window Feature

Teaching the same limit twice automatically centers a 20 mm window on the taught position.

General Notes on Programming

- The sensor returns to Run mode if the first TEACH condition is not registered within 120 seconds.
- After the first limit is taught, the sensor remains in Program mode until the TEACH sequence is finished.
- To exit Program mode without saving any changes, press and hold the programming push button for more than 2 seconds (before teaching the second limit). The sensor reverts to the last saved program.

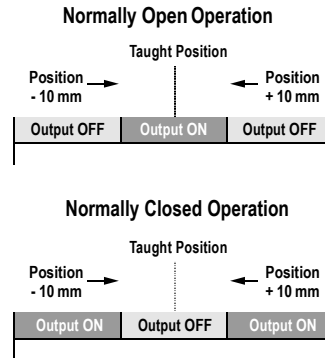







Figure 4. Using the Auto-Window feature for programming each output

	Procedure		Result
	Push Button (0.04 sec ≤ Click ≤ 0.8 sec)	Remote Line (0.04 sec < T < 0.8 sec)	
Programming Mode	Press and hold push button 	No action required; sensor is ready for 1st limit teach	Output LED: ON Red Power LED: ON Green (good signal) or ON Red (no signal)
Teach First Limit	Position the target for the first limit	Position the target for the center of the window	Power LED: Must be ON Green
	"Click" the push button 	Single-pulse the remote line 	TeachAccepted Output LED: Flashing Red TeachUnacceptable Output LED: ON Red
Re-Teach Limit	Without moving the target, "click" the push button again 	Without moving the target, single-pulse the remote line again 	TeachAccepted Output LED: Yellow or OFF TeachUnacceptable Output LED: Flashing Red

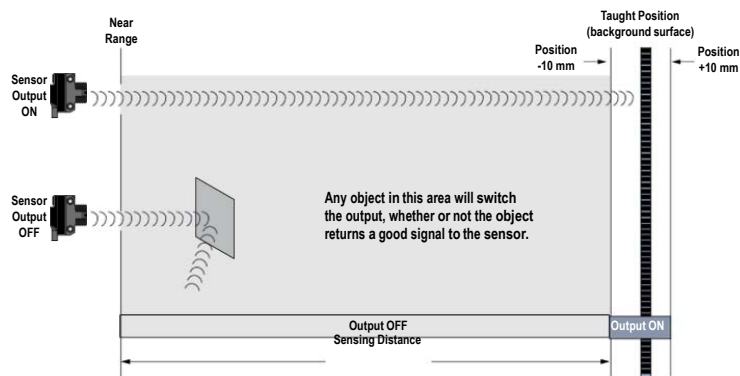

Figure 5. An application for the Auto-Window feature (retroreflective mode)

Normally Open/Normally Closed Operation Select

The sensor can be configured for either normally open or normally closed operation via the remote teach wire (white).

A series of three pulses on the line will toggle between normally open (NO) and normally closed (NC) operation.

Normally open is defined as the output energizing when the target is present. Normally closed is defined as the output energizing when the target is absent. (See Figure 3. Teaching independent minimum and maximum limits on page 4 and Figure 4. Using the Auto-Window feature for programming each output on page 5.)

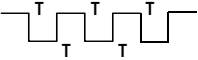
	Procedure		Result
	Push Button 0.04 sec ≤ Click ≤ 0.8 sec	Remote Line 0.04 sec < T < 0.8 sec	
Toggle between NO/NC Operation	Not available via push button	Triple-pulse the remote line 	Either Normally Open or Normally Closed operation is selected, depending on previous condition.

Push Button Lockout

Enables or disables the push button to prevent unauthorized personnel from adjusting the program settings.

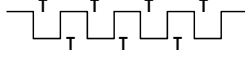
	Procedure		Result
	Push Button 0.04 seconds ≤ "Click" ≤ 0.8 seconds	Remote Line 0.04 sec < T < 0.8 sec	
Push Button Lockout	• Not available via push button	• Four-pulse the remote line 	Push buttons are either enabled or disabled, depending on condition.

CONNECTIONS

NPN (Sinking) Output Models

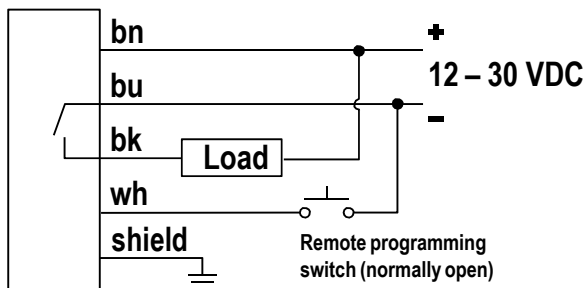

PNP (Sourcing) Output Models

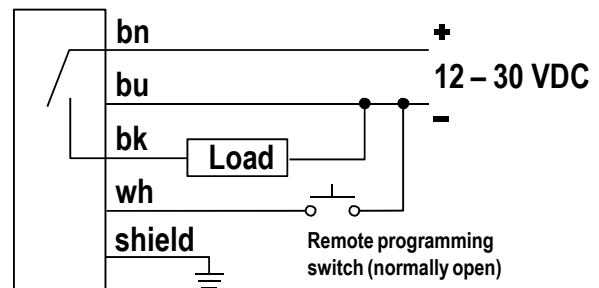

Cable and QD hookups are functionally identical.

It is recommended that the shield wire be connected to earth ground. Shielded cordsets are recommended for all QD models.

TECHNICAL DATA

Sensing Range:	50 ... 500 mm
Supply Voltage:	12 – 30 VDC (10% maximum ripple); 25 mA max (exclusive of load)
Ultrasonic Frequency:	300 kHz, rep. rate 7.5 ms
Supply Protection Circuitry:	Protected against reverse polarity and transient voltages
Output Configuration:	SPST solid-state switch conducts when target is sensed within sensing window; one NPN (current sink- ing) or one PNP (current sourcing), depending on model.
Output Protection:	Protected against short-circuit conditions
Output Rating:	Rating: 100 mA maximum load; see Application Note 1 Off-state leakage current: less than 10 μ A (sourcing); less than 200 μ A (sinking); see Application Note 2 ON-state saturation voltage: NPN: less than 1.6V @ 100 mA; PNP: less than 3.0V @ 100 mA
Output Response:	15 milliseconds
Delay at Power Up:	300 milliseconds
Temperature Effect:	Non-encapsulated models: \pm 0.05% per $^{\circ}$ C from -20 to +50 $^{\circ}$ C, \pm 0.1% per $^{\circ}$ C from +50 to +60 $^{\circ}$ C
Repeatability:	0.7 mm
Minimum Window Size:	5 mm
Hysteresis:	1.4 mm
Indicators:	Range Indicator (Red/Green) and Teach/Output Indicator (Yellow/Red) Range Indicator: Green - Target is within sensing range; Red - Target is outside sensing range; OFF - Sensing Power is OFF Teach/Output Indicator: Yellow - Target is within taught limits; Red - Sensor is in TEACH mode OFF - Target is outside taught window limits;
Adjustments:	Sensing Window Limits: TEACH-mode programming of near and far window limits may be set using the push button or remotely via TEACH input
Construction:	ABS housing, TPE Push Button, ABS Push Button housing, Polycarbonate lightpipes
Connections:	4-pin M12 connector
Environmental Rating:	Leakproof design, rated NEMA 6P; IEC IP67 or IP68 depending on model; UL Type 1
Operating Temperature:	-20 ... +60 $^{\circ}$ C
Relative Humidity:	100% (non-condensing)
Vibration and Mechanical Shock:	All models meet Mil. Std. 202F requirements method 201A (vibration: 10 to 60 Hz max., double amplitude 0.06", maximum acceleration 10G). Also meets IEC 947-5-2 requirements: 30G 11 ms duration, half sine wave.
Temperature Warmup Drift:	See Temperature Compensation on page 2
Application Notes:	1. If supply voltage is >24VDC, derate maximum out- put current 5 mA/ $^{\circ}$ C above 50 $^{\circ}$ C. 2. NPN off-state leakage current is < 200 μ A for load resistances > 3 k Ω or optically isolated loads. For load current of 100 mA, leakage is < 1% of load current. 3. Objects passing inside the specified near limit may produce a false response.
Certifications:	

OVERALL DIMENSIONS

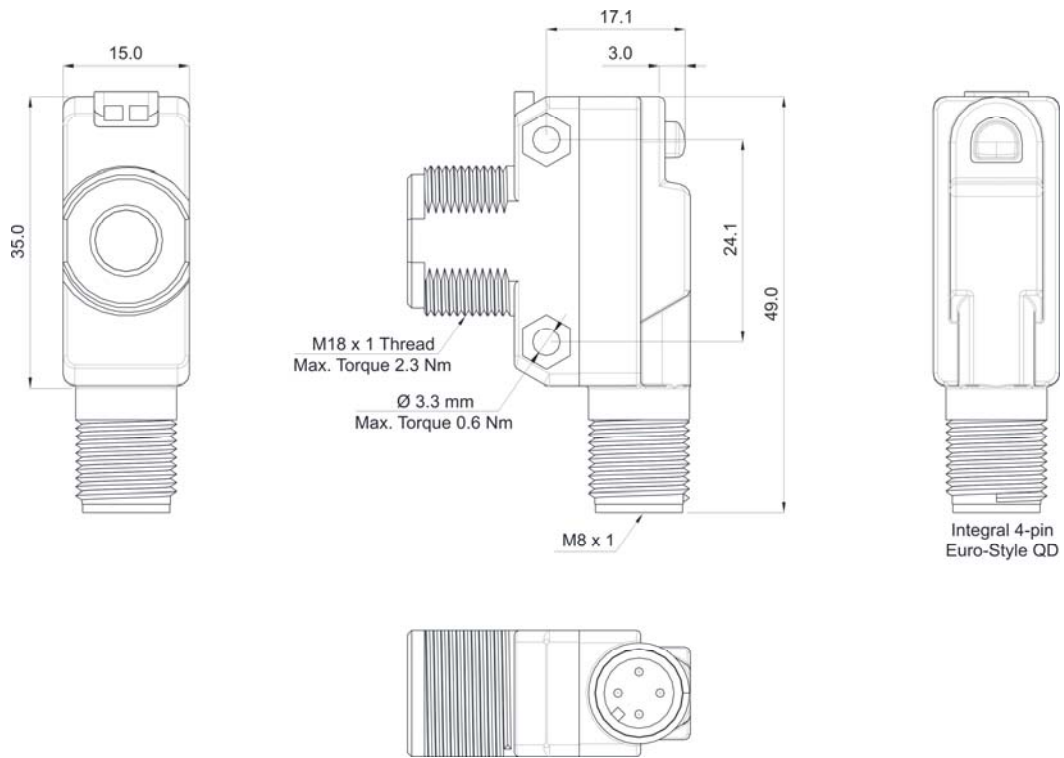

Dimensions in mm

DATALOGIC AUTOMATION srl

Via Lavino 265 - 40050 Monte S.Pietro - Bologna – Italy

Tel: +39 051 6765611 Fax: +39 051 6759324

www.datalogic.com

DATALOGIC AUTOMATION reserves the right to make modifications and improvements without prior notification

821002641 Rev.B