



inform

On-Line UPS

**SINUS LCD SERIES
User manual**

1K/2K/3KVA

Table of Contents

1.	Important Safety Instruction	2
1.1.	An Important Notice	2
1.2.	Storage Instruction	3
2.	Product Introduction	3
2.1.	General Characteristics.....	3
2.2.	Special Features.....	4
3.	UPS Functional Descriptions.....	5
3.1.	UPS Front Panel Display Descriptions	5
3.2.	Real Panel Descriptions.....	8
3.3.	Operating Modes & Voltage System Configurations	9
3.4.	Communication Port Explanation	13
4.	Installation and Operation	15
4.1.	Unpacking.....	15
4.2.	Selecting Installation Position	16
4.3.	Set up.....	17
4.4.	Operation.....	20
5.	UPS Working Principle	32
5.1.	UPS System Block Diagram	32
5.2.	When Utility is Normal	33
5.3.	When Utility is Abnormal/Absent	34
5.4.	Overload Condition	35
5.5.	Inverter Failure	36
5.6.	Inverter/Internal Over temperature	36
5.7.	Inverter Over	36
6.	Maintenance Guide.....	37
6.1.	Trouble Shooting	37
6.2.	Error Codes and Their Descriptions.....	39
6.3.	Maintenance	39
7.	Bundle Software Installation Guide	40
7.1.	Hardware Installation	40
7.2.	Software Installation.....	40
8.	Optional Communication Cards	41
8.1.	R2E (2nd RS-232) card.....	41
8.2.	USE (USB) card.....	41
8.3.	DCE (Dry Contact) card	42
8.4.	SNMP Cards.....	43
9.	Specifications	44

1. Important Safety Instruction

1.1. *An Important Notice*

1. Do not open the case, as there are no serviceable parts inside. Your Warranty will be void.
2. Do not try to repair the unit yourself; contact your local supplier or your warranty will be void.
3. If liquids are split onto the UPS or foreign objects dropped into the unit, the warranty will be null and void.
4. Do not install the UPS in an environment with sparks, smoke or gas.
5. This UPS is equipped with an EMI filter. To prevent potential leakage current hazard, ensure that the AC main supply is securely grounded.
6. This UPS is designed to be installed and commissioned in a sheltered, controlled environment as follows:
 - Operating temperature 0-40°C and 30-90% non-condensing humidity.
 - Always avoid contact with direct sunlight.
 - Installing the UPS in inflammable or hazardous environment.
 - Dusty, corrosive and salty environments can do damage to any UPS.
 - Install the UPS indoors as it is not designed for installation outdoors.
7. To prevent any overheating of the UPS, keep all ventilation openings free from obstruction, and do not place anything on top of the UPS. Keep the UPS rear panel 20 cm away from the wall or other obstructions.
8. The battery will discharge naturally if the system is unused for any length of time.
9. Install the UPS away from objects that give off excessive heat and areas that are excessively wet.
10. Always switch off the UPS and disconnect the batteries when relocating the UPS.
11. It should be recharged every 2-3 months if unused. If this is not done, then the warranty will be null and void. When installed and being used, the batteries will be automatically recharged and kept in top condition.
12. Make sure that the AC Utility outlet is correctly grounded.
13. Please ensure that the input voltage of the UPS matches the utility supply voltage. Use a certified input power cable with the correct plugs and sockets for the appropriate voltage system.

1.2. Storage Instruction

For extended storage in moderate climate, the batteries should be charged for 12 hours every 3 months interval by connecting the UPS to the utility supply and switch on input breaker located at UPS rear panel. Repeat this procedure every 2 months if the storage ambient temperature is above 30°C.

2. Product Introduction

2.1. General Characteristics

True online technology continuously supplies your critical device with a stable, regulated, transient-free pure sine wave AC Power.

1. High-efficiency PWM sine-wave topology yields an excellent overall performance. The high crest factor of the inverter handles all high in-rush current loads without the need to upgrade the power rating.
2. User-friendly Plug-and-Play design allows hassle-free installation. All units up to 3kVA are supplied with input cables and output sockets as standard.
3. Built-in Maintenance-free sealed-type battery minimises the need for frequent after-sales service.
4. To protect the unit from overloading, the UPS will automatically switch to bypass mode in 30 seconds if loading is at 105%~ 120% of rated capacity. It will automatically switch back to inverter mode once overload condition ceases.
5. Should the output becomes short-circuited, the UPS puts the system on stand-by mode, provide visual & audible alarm, and cuts the output supply automatically till the short circuit situation is resolved manually.

2.2. Special Features

1. High Frequency Transformer-less technology with rack/tower convertible enclosure enables the UPS for integration even in the most difficult of environment with space constraints.
2. This UPS is equipped with fully digitalized control logic for greater functionality and enhanced high level of power protection. Digital signal processing (DSP) also provides the UPS with powerful communication capability, which enhances the flexibility for easy remote control and monitoring
3. Wide input voltage tolerance from 120V~288V allows under-voltage or over-voltage correction without unnecessary battery drain and helps extend the battery life span.
4. DC-start function ensures the start-up of UPS even during power outages.
5. Revolutionary battery management circuit analyzes battery discharging status to adjust battery cut-off point and extend the batteries' life span.
6. Active Power Factor Correction (PFC) control function constantly maintains the UPS Input Power Factor (PF) at > 0.99 for superb energy efficiency.
7. Selectable Bypass input voltage tolerance (Sensitivity low/high) to prevent under or over voltage being supply to the loads at Bypass mode. The selectable Voltage ranges are (i) Sensitivity Low : 130/260V & (ii) Sensitivity High : 130/260V.
8. Vast Selectable Output Voltages 200/208/220/230/240) to meet various voltage systems.
9. The UPS is designed to comply with various stringent international standards for Electromagnetic Interference & protection (EMC).

3. UPS Functional Descriptions





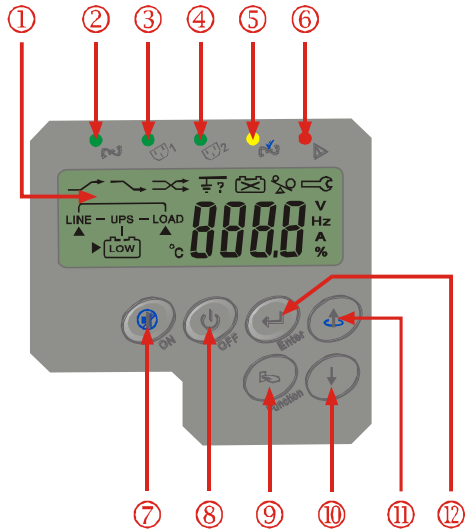

3.1. UPS Front Panel Display Descriptions

3.1.1. LCD panel

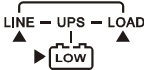

- ① LCD Display
 - ② Green LED steadily lights up to indicate that the Utility input voltage is within the window (160Vac~288Vac); the LED flashes flickeringly to indicate that the Utility input voltage is within the acceptable window (120Vac~159Vac).
 - ③、④ Green LED lights up to indicate there is an output available at the Programmable Outlet 1 & Programmable Outlet 2.
 - ⑤ Amber LED lights up to indicate the Bypass Input is normal.
 - ⑥ UPS Fault LED
 - ⑦ UPS On/Alarm Silence
 - ⑧ UPS OFF Switch
 - ⑨ Special functions log in/out
 - ⑩ Go to next page
 - ⑪ Go to previous page or change the setting of the UPS.
 - ⑫ To re-confirm the change of UPS Setting
- ◎ Manual Bypass : Press "⑦ON-KEY" and "⑪Up-KEY" key simultaneously for approx. 3 seconds to transfer from "Inverter to Bypass" (the bypass led continuously "blink" and the buzzer will beep intermediately or "Bypass to Inverter", when the UPS is on Line Mode and the Bypass Voltage Window is Normal.

3.1.2.1 Symbols on the LCD Display Panel

Item	Symbol	Description
1	LINE	Utility or Bypass Source
2		Battery Low
3		Battery Abnormal
4		UPS Overloading
5		Site Wiring Fault
6		UPS Working in Service Mode
7	OFF	UPS Shutoff
8	FAIL	UPS Abnormal Lock
9		UPS Flow Chart
10		4 Digits Measurement Display
11		Indicate the item desired to be measured
22	Er05	Battery Weak or Dead
23	Er06	Output Short Circuit
24	Er10	Inverter Over-current
25	Er11	UPS Overheat
26	Er12	UPS Output Overloading
27	Er**	Other Error Code

3.2. Real Panel Descriptions

230V

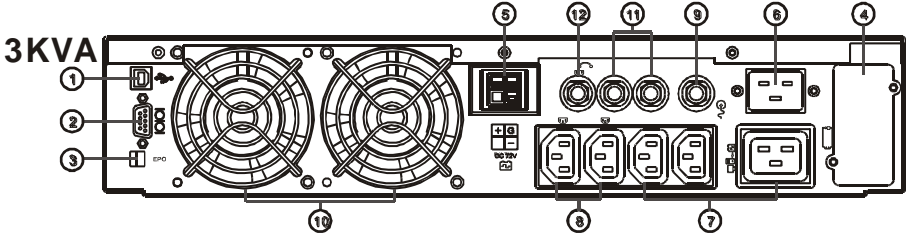
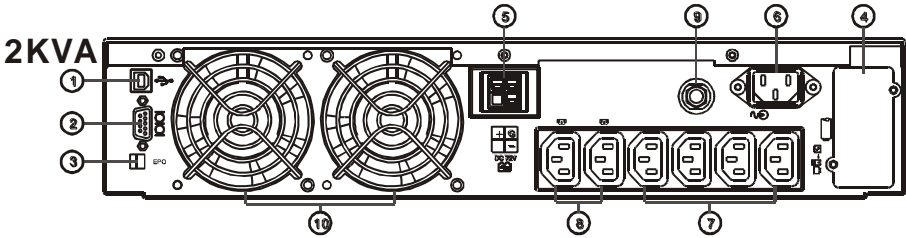
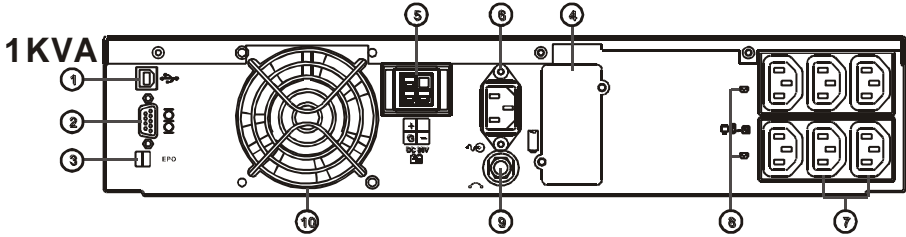

1. USB Port
2. RS232 Port
3. Emergency Power Off (EPO) Dry Contact Signal inputs
4. Communication Card Options Slot
5. External Battery Connector
6. AC power connection socket
7. AC Outlets
8. Two programmable outlets
9. Utility Input circuit breaker
10. Cooling Fans
11. Output circuit breaker for two outlets
12. Output circuit breaker for two programmable outlets

3.3. Operating Modes & Voltage System Configurations

Download and open the “UPS Setting Tool” Software to see the screen as below

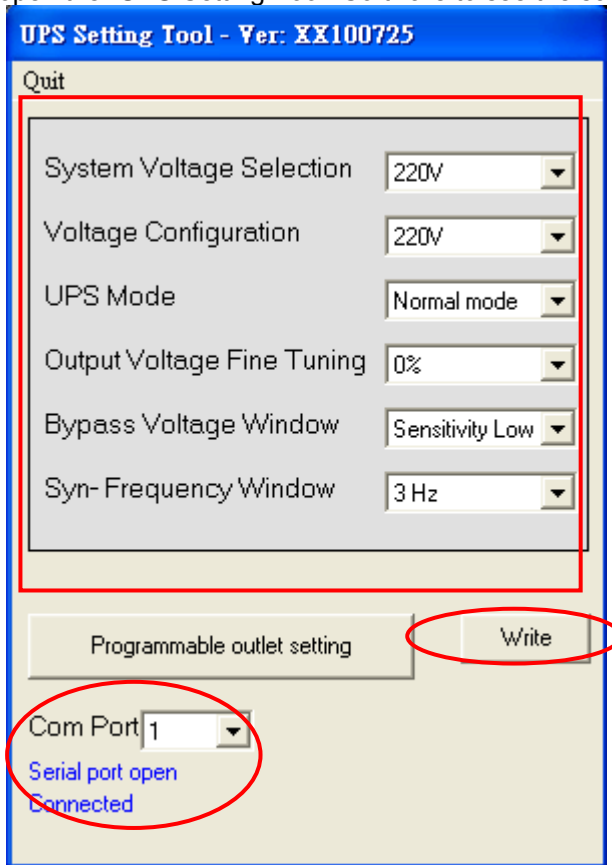

3.3.1. System Configuration Settings

1. System Voltage Selection : Select Input Voltage 220V
2. Voltage Configurations : Select UPS Output Voltage 200V/208V/220V/230V/240V
3. UPS Modes : Select Normal/CF50*/CF60* Mode
4. Output Voltage Fine Tuning : Output Voltage Regulation from 0 ~ $\pm 3\%$

5. Bypass Voltage Windows : Sensitivity: Select Sensitivity Low/Sensitivity High**

	Sensitivity Low	Sensitivity High
220V System	184V ~ 260V	194V ~ 260V

6. Syn-Frequency Window : Select 3Hz/1Hz Inverter Freq synchronizing range
7. KVA : Key in 1 or 2 or 3 for the UPS Kva rating
8. Com Port : Select the Com Port of PC
9. Click on "Write" to confirm the configuration settings. The UPS will beep twice to acknowledge setting is successful.
10. Turn off the UPS after setting is complete to make sure that all the new setting values are written into EEPROM successfully, then re-start the UPS to enable the new settings.

Note:

***CF50/CF60 = Frequency Converter mode 50 to 60Hz or vice versa**

****Sensitivity Low : 130/260V, High: 130/260V**

3.3.2. Programmable outlet setting

The UPS is equipped with 2 programmable outlets for use to supply to less critical loads. These outlets can be disabled to shed the less critical loads during back-up modes or overload conditions to maintain quality power supply to the more critical loads connected to the UPS.

Click on the “Programmable outlet setting” bar to enter to the setting screen as shown below.

The screenshot shows a software window titled "Programmable Outlet Scheme" with a close button in the top right corner. The main heading is "Programmable Outlet Settings".

Programmable Outlet 1

- Outlet Turn On,After UPS On: 0 Second (0-3600).
- Outlet Turn Off,After AC Failure: 0 Second (0-3600).
- Outlet Turn On,After AC Recovery: 0 Second (0-3600).
- Outlet Turn Off,When Battery Low: 50 % (20-80)
- Outlet Turn Off,When UPS Overload: *Setting*

Programmable Outlet 2

- Outlet Turn On,After UPS On: 0 Second (0-3600).
- Outlet Turn Off,After AC Failure: 0 Second (0-3600).
- Outlet Turn On,After AC Recovery: 0 Second (0-3600).
- Outlet Turn Off,When Battery Low: 50 % (20-80)
- Outlet Turn Off,When UPS Overload: *Setting*

Manual Control Switch

- Programmable Outlet 1**: *On* | *Off*
- Programmable Outlet 2**: *On* | *Off*

1. Outlet Turn On After Turn on UPS – *select the time to automatically enable this outlet within the specified time when the UPS is powered on. If “0” sec is selected, the outlet will be enabled once the UPS is powered on.*
2. Outlet Turn Off After AC Failure – *select this option to automatically disable the outlet within the specified time after utility outage to shed the less critical loads to provide longer battery back-up time for the other more critical loads connected to the UPS.*
3. Outlet Turn On After AC Recovered – *select this option to automatically enable the outlet within the specified time after the utility is restored.*
4. Outlet Turn Off When Battery Lower than - *select this option to automatically disable the outlet at the specified remaining battery power capacity(%) during battery mode to shed the less critical loads to prolong battery back-up time for the other more critical loads connected to the UPS.*
5. Outlet Turn Off When Overload – *select this option to automatically disable the outlet during overload condition (bypass mode) to possibly allow the more critical loads:*
 - a) *To be continually supplied via Bypass without shut down*
6. You have to select the "Setting" menu to configure new parameters. The calibration is confirmed successfully after the UPS beeps twice. Turn off the UPS and remove the input source to make sure that those new parameters are written into EEPROM successfully, then re-start the UPS to enable the new settings.
7. Manual Control Switch – Click “On” or “Off” to manually enabled or disabled the programmable outlets, overriding all previous settings.

3.4. Communication Port Explanation

The UPS is equip with EPO dry contacts input, true RS232 & USB Communication port as standard to provide communication with bundled UPS monitoring software for remote monitoring of UPS status via PC.

There are 4 other optional interface cards available to meet various communication needs, i.e. DCE (dry contact relay card) 、 R2E、 USE and SNMP/WEB card (Please consult Ch8).

The bundled software of the UPS is compatible with many operating systems such as Windows 98, & 2000, ME, NT and XP. For other applications such as Novell, NetWare, Unix, Linux, please contact your local dealer for suitable software.

All the communication ports (including optional cards) can be active & use simultaneously to monitor the UPS status. However only 1 communication interface at any one time with the highest priority has the ability to command & control the UPS. The priority of these communication interfaces are as follow:

Highest Priority (in descending order),

- 1) EPO input port
- 2) Optional Interface card
- 3) USB
- 4) RS232

3.4.1. True RS232 Port Descriptions

The RS232 interface shall be set as follows :

Baud Rate	2400 bps
Data Length	8 bits
Stop Bit	1 bit
Parity	None

The Pin Assignments of the true RS232 port are illustrated as follows :



Pin 3: RS232 Rx
Pin 2: RS232 Tx
Pin 5: Ground

3.4.2. USB Port Descriptions

The USB communication protocol definition as below :

1. Comply with USB version 1.0, 1.5Mbps
2. Comply with USB HID Version 1.0.
3. The Pin Assignments of the USB port:

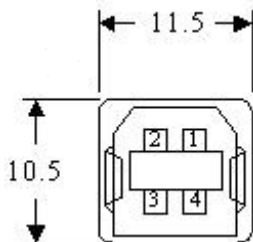

1 → VCC (+5V)
2 → D -
3 → D +
4 → Ground

3.4.3. EPO

The Pin assignments of the EPO Input port are:

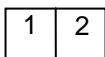

1 → EPO+
2 → Ground

To enable the EPO function, please short Pin 1 & 2.

4. Installation and Operation

Read the Safety Instruction guide (page 2 to 3) before installing the UPS

4.1. Unpacking

Inspect the UPS upon receipt. The manufacturer designed robust packaging for your product. However, accidents and damage may occur during shipment. Notify the forwarder and dealer if there is damage.

The packaging is recyclable; save it for reuse or dispose of it properly.

Remove the UPS from the carton box.

Check the package contents. Standard content shall includes :

- 1 set of **User's Manual**
- 2 pcs of **IEC output cables (for UPS with IEC sockets only)**
- 1 pc of **AC Input Power Cord**
- 1 set of **UPS communication software with RS232 cable**
- 1 set of **Tower/Rack Accessories Kit as below:**

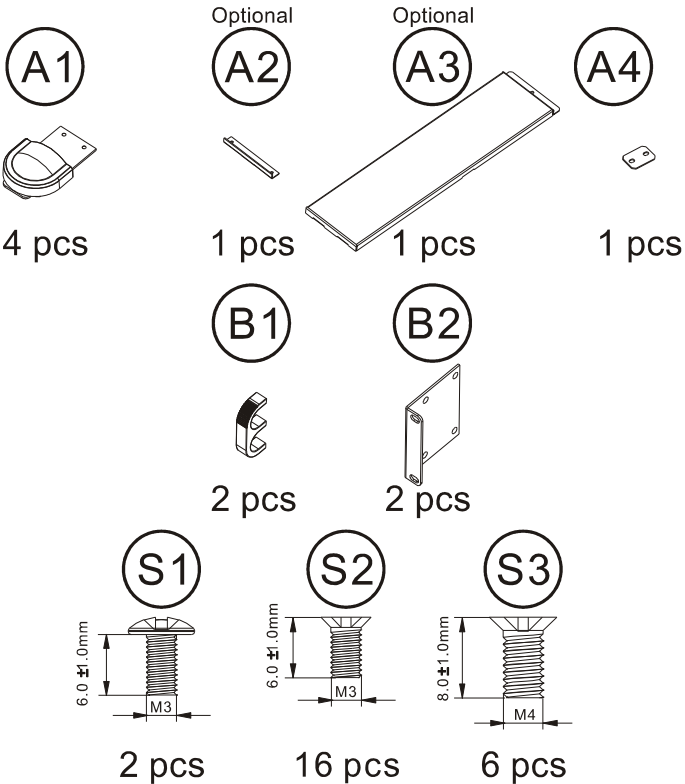

4.2. Selecting Installation Position

The UPS is heavy. Select a location sturdy enough to handle the UPS weight.

To ensure proper operation and long operating life, always position the UPS according to the following requirement :

1. Keep minimum 20cm (8 inches) distance clearance from the rear panel of the UPS to avoid any obstructions.
2. Do not block the air-flow to the ventilation louvers of the unit.
3. Please ensure the installation site is free from excessive dust and the ambient temperature and humidity should be within the specified limits.
4. Do not place the UPS in a dusty or corrosive environment or near any flammable objects.
5. This UPS is not designed for outdoor use.

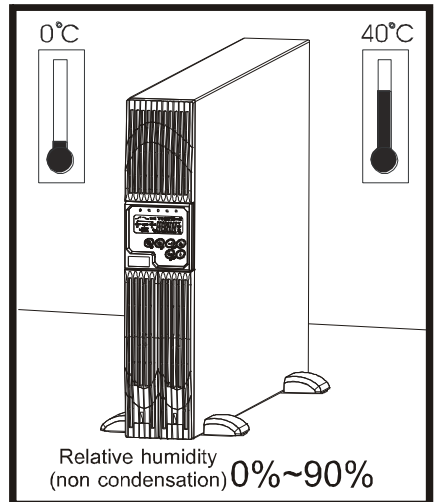
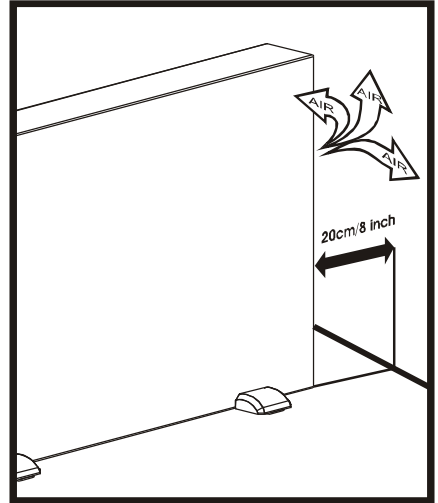

4.3. Set up

Tower Configuration Setup

Step 1

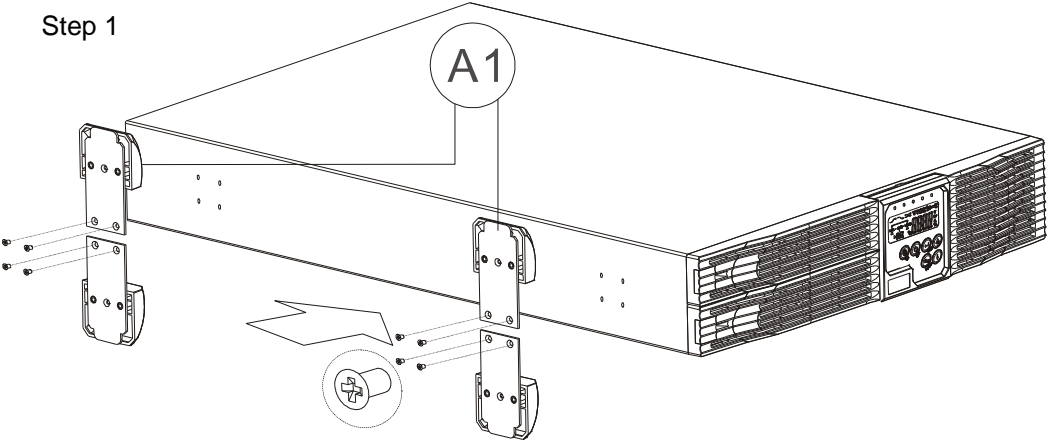

Step 2

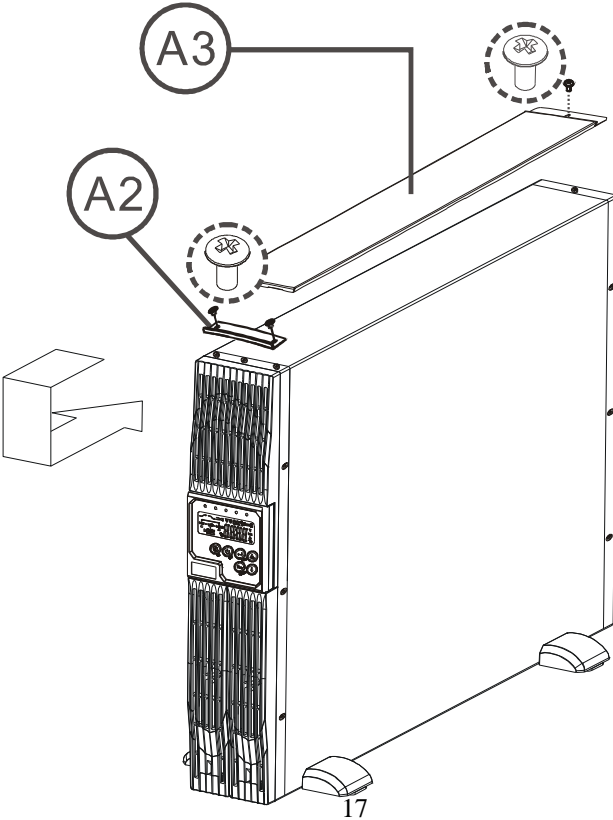

Rack-Mount Configuration Setup

Step 1

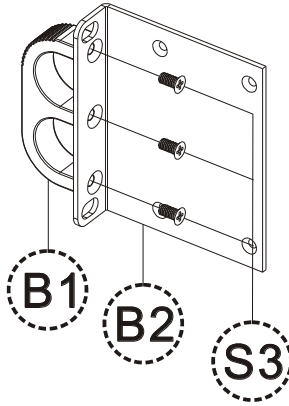

Step 2

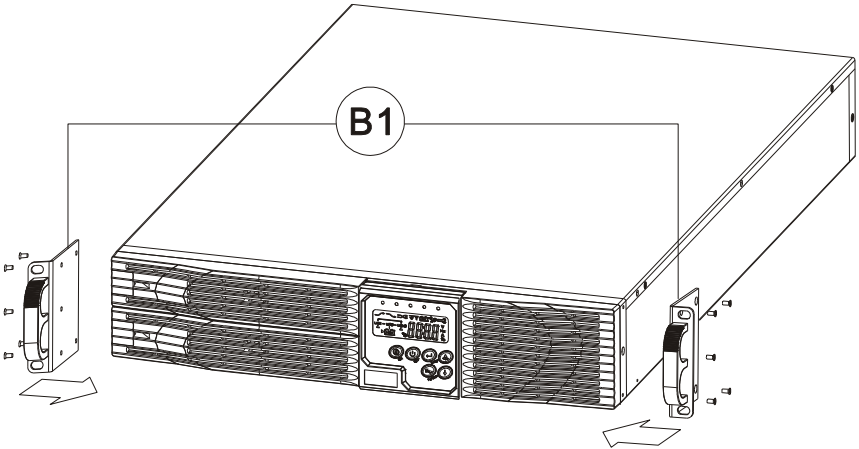

Step 3

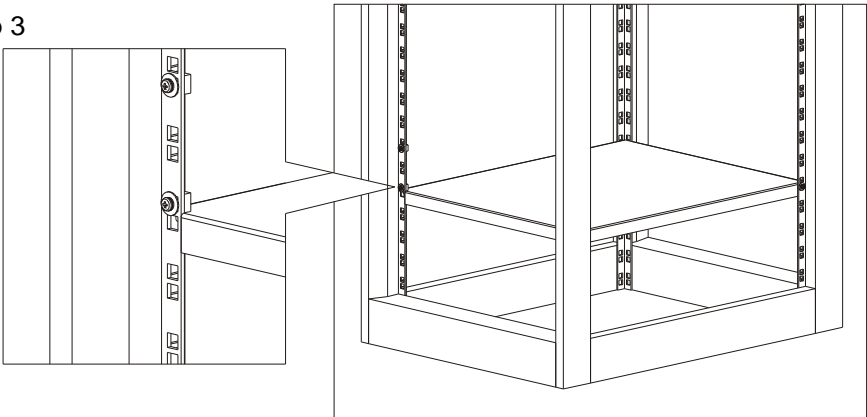

Step 4

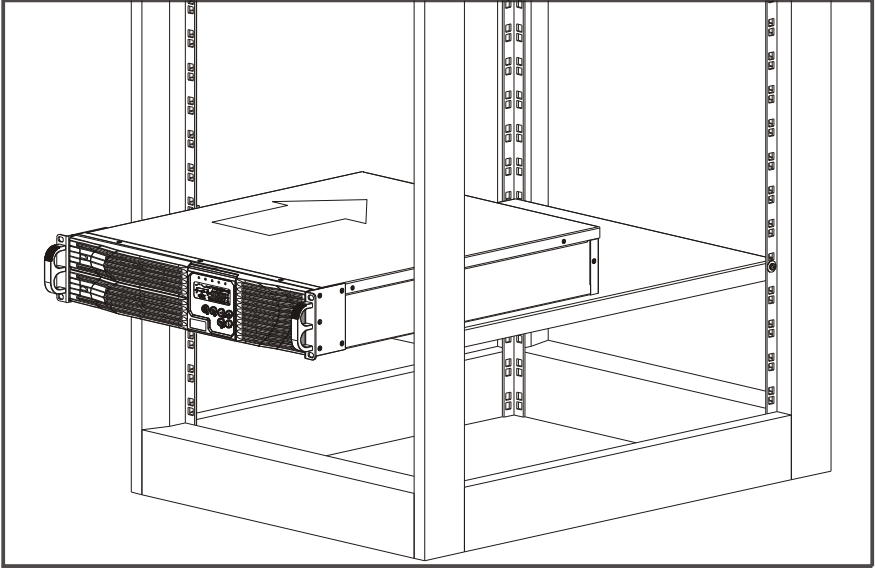

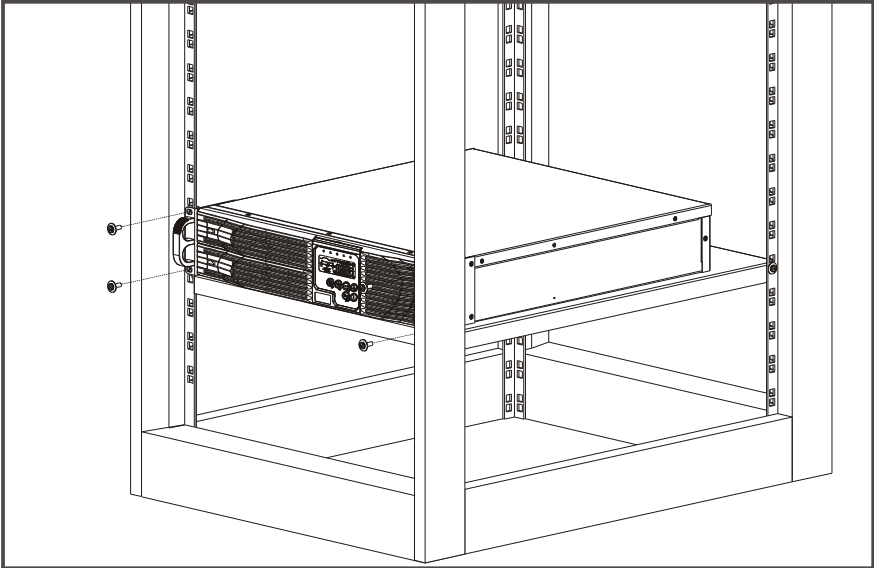

Step 5





4.4. Operation

4.4.1. LCD panel

4.4.2.1 Start Up In Normal Mode

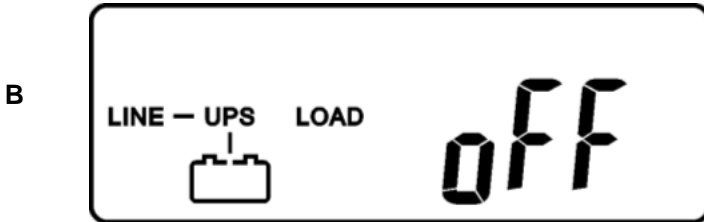
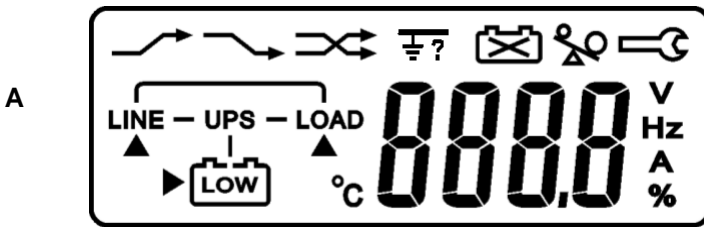
- (1) Make sure the voltage of Utility matches with the input voltage window of the UPS.
- (2) Connect the UPS to the wall Receptacle of the Utility. Turn on the "ON" switch to start up the UPS. LED  and  light up to indicate the Utility and the Bypass are normal. The LCD will illustrate from drawing A to drawing B.



- (3) Then, the UPS is on Bypass Mode now and it will proceed self-test automatically. If there is no abnormal message occurred, it means the pre-start up of the UPS is successful and the charger starts to charge the batteries.
- (4) Press the UPS On Switch  for approx. 3 seconds, then the Buzzer sounds twice. If the UPS start-up is successful, the LCD display changes from drawing B to drawing C.

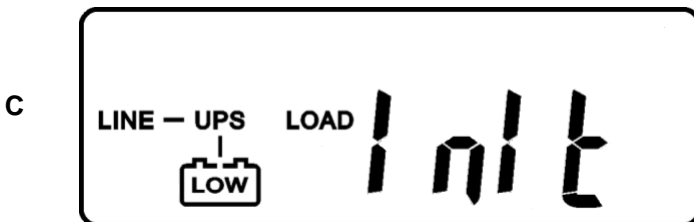

(5) In case of failure in self-test, the LCD display will illustrate as drawing D, then, an error code or error status will be shown on the screen.

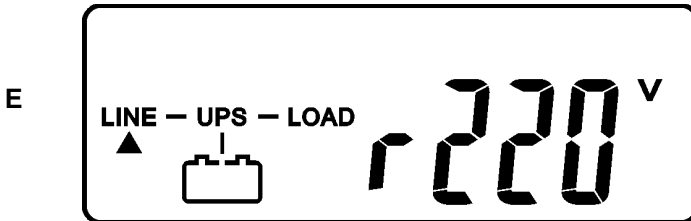
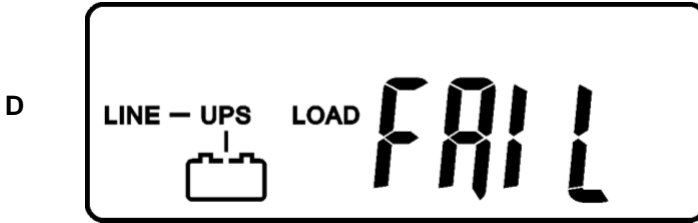

(6) Your start-up operation of the UPS is completely now as illustrated as drawing E. Make sure the UPS is plugged onto the wall receptacle for charging at least 8 hours and the batteries of the UPS are fully charged

4.4.2.2 Start-up in Battery Mode (Cold Start)

- (1) Make sure the UPS has already been installed with batteries.
- (2) Press the UPS On switch to awake the UPS for approx. 3 seconds, and then the buzzer sounds twice. The LCD display will illustrate from Drawing A to drawing G.

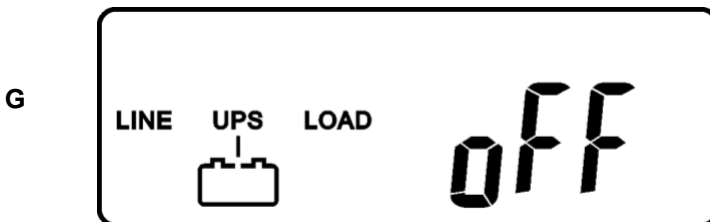

(3) Press the UPS On switch of the UPS again for approx. 3 seconds till the LCD display illustrates from drawing G to drawing H, then the UPS will be in self-test Mode. The UPS may offer energy to the output in a minute, and the LCD display illustrates as drawing I. In case of failure in pushing the UPS On Switch in 10 seconds, the UPS will automatically turn off.

H

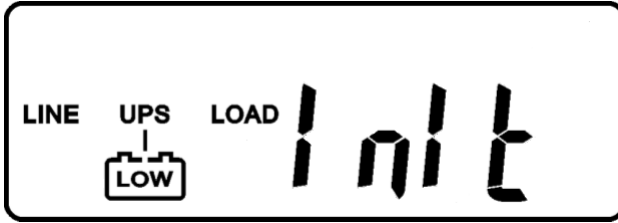

I

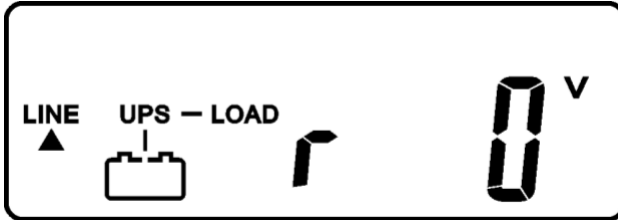

4.4.2.3 Check Measured Values & Figures detected by UPS

(1) If you would like to check the measured values & messages, please use scroll up (↑) and scroll down (↓) key pads. When you use scroll down key pad, the LCD display will illustrate in sequence from Drawing E(Input Voltage) → Drawing J(Input Frequency) → Drawing K(UPS Output Voltage) → Drawing L(UPS Output Frequency) → Drawing M(UPS Output Load percentage) → Drawing N(UPS Battery Voltage) → Drawing O(UPS inner temperature

J

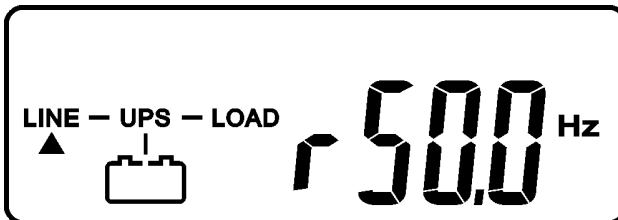

K

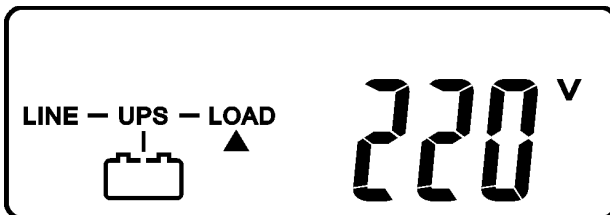

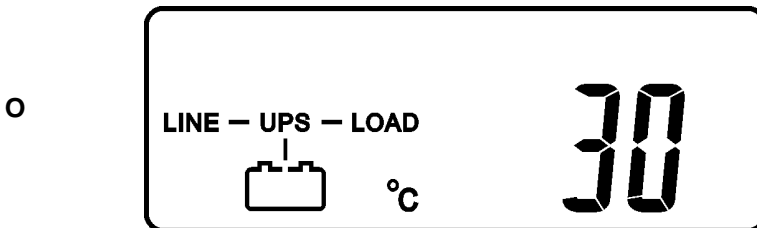
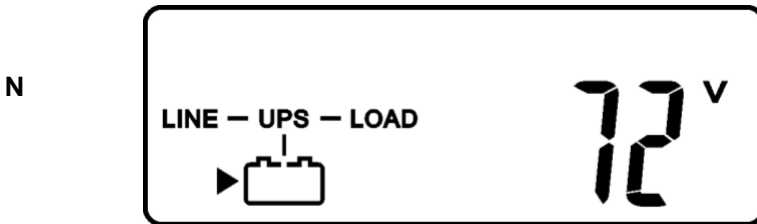
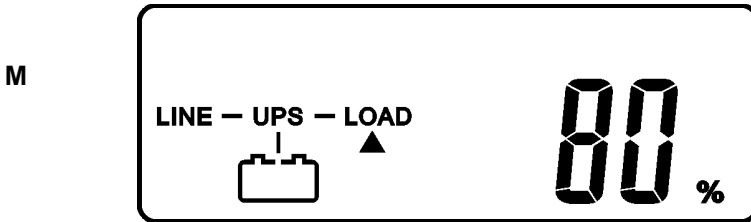
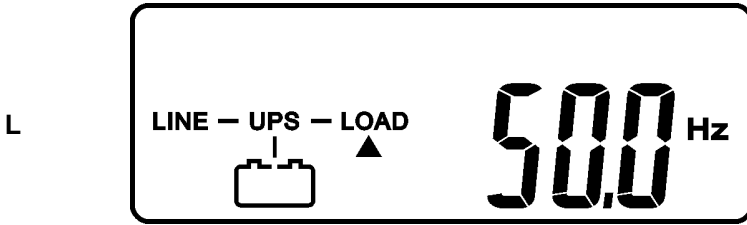

4.4.2.4 UPS Default Data and Special Function Execution

- (1) After UPS is turned on successfully, use  key pad to change the LCD Display screen to drawing P1.

P1

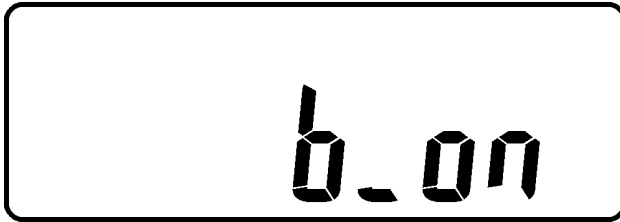

P2

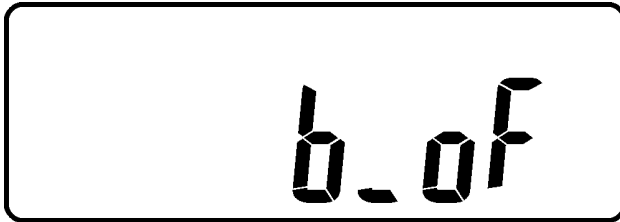

(2) Press  key pad to scroll down the LCD screen, then check the UPS settings. The LCD display will show in sequence: Drawing P1(buzzer)→Drawing Q1(self test)→Drawing R1(Bypass Voltage)→Drawing S(Output Frequency Synchronized Window)→Drawing T(Inverter Output Voltage)→Drawing U1(UPS Operation Mode)→Drawing V(Output Voltage Fine Tuning)

Q1



Q2

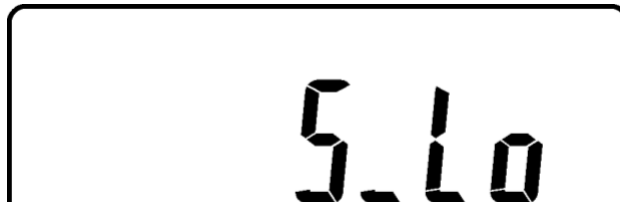

R1

R2

5.41

S

5103 Hz

T

0220^v

U1

norL

U2

cF50 Hz

U3

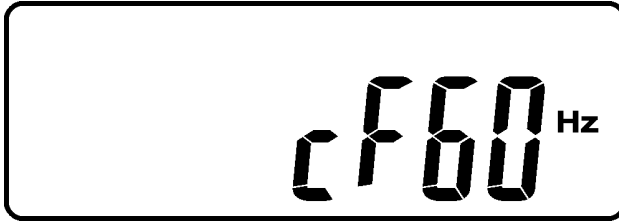

V

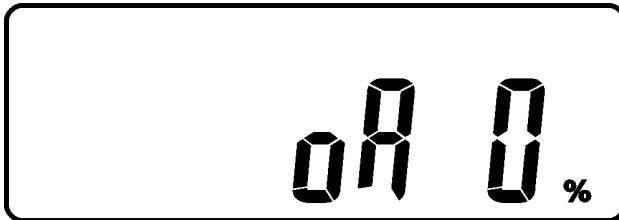

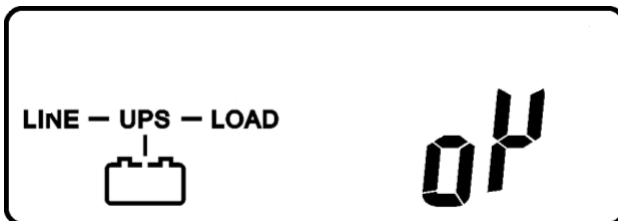

- (3) Press scroll up  key pad, you may execute special functions. The functions include Buzzer ON (as drawing Q1) or buzzer OFF (as drawing Q2, Alarm silence for UPS warning) and self-test OFF (as Drawing R2. UPS will execute battery test for 10 seconds, if the self-test is successful, it show as Drawing W; otherwise, it will show as Drawing D & error message at the same time.

W



4.4.2.5 UPS Default Settings and Their Alternatives

- (1) Make sure the UPS is not "ON" yet, which means it is not in-Line Mode or Backup Mode. Press on ON Switch  and scroll down  key pads simultaneously for approx. 3 seconds, the buzzer will sound twice, the LCD

display screen shows as drawing P1, then the UPS is under setting mode now.

- (2) To scroll down the LCD screen, you may refer to Chapter 4.4.1.3. point 1.
- (3) Except Buzzer(as Drawing P1 & P2) and self-test(Q1 & Q2), all the rest default settings may be changed by pressing scroll up (↑) key pad.
- (4) Drawing S1 and S2 mean the bypass input acceptable window, it can be 176Vac~ 264Vac , or 187Vac~264Vac .
- (5) Drawing S means the bypass frequency window of the inverter output, the acceptable setting values are +/-3Hz and +/-1Hz.
- (6) Drawing T means the acceptable Inverter Output Voltage, of which voltage is 200V, 208V, 220V, 230V, or 240V .
- (7) Drawing U1, U2 and U3 mean the operation modes of the UPS, of which alternative is Online, fixed 50Hz Output or fixed 60Hz Output.
- (8) Drawing V means the adjustments of the Inverter Output, which may be calibrated as 0%, +1%, -1%, +2%, -2%, +3%, or -3%.
- (9) When all the setting changes are done, you have to press enter (↵) key pad to save all the changes when the LCD screen shows as drawing X. All those changes will be activated only when the UPS is re-turned on. The LCD screen will be back to the original screen before setting.

X



- (10) Turn off the UPS and the input breaker of the Utility.
- (11) Your Setting changes are complete.

4.4.2.6 UPS Is Off Due to Unknown Reason and Its Trouble Shooting

- (1) If there is a serious abnormal condition occurred, the UPS will lock itself in "OFF" position as shown in the drawing Y and a abnormal message will show in the LCD screen.

Y



- (2) For some special conditions, the UPS will lock itself; however, it is still allowed to have bypass output in most of conditions and the LCD screens will show as drawing Z and error message will be shown on the screen.

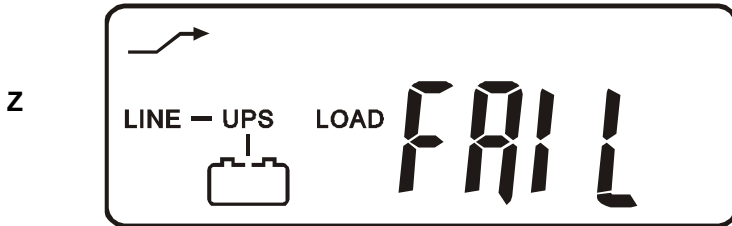

- (3) To release the UPS lock, please proceed the followings:
- Check those error messages recorded
 - Check to see Chapter 6.2 to trouble shoot the problem of the UPS; otherwise, consult your local distributor for service.
 - Press  key pad for 5 seconds and buzzer will sound twice.
 - Turn off the Breaker of the Utility Input.
 - The UPS lock problem is solved now.

4.4.2.7 Shut Off

- Press  key pad for about 5 seconds, the Inverter output will be turned off, then the output load is supplied by Bypass loop and the LCD screen shows as drawing B.
- Turn off the input of the UPS.
- The UPS is turned off completely.

4.4.2. Status & Alarm Buzzer

The following table helps to define some of the common UPS statuses with respect to their buzzer beep descriptions.

Status Definitions	Buzzer Beep Descriptions
UPS faulty, Inverter shutdown. All functions inhabited.	Long Continuous Beep
UPS faulty, loads continue to be supplied via Inverter or Bypass.	Single successive beep with ~ 2 sec interval
battery mode	Single short successive beep with ~1 sec interval
battery low	Very quick and short successive beep
confirm/RS232 port receiving	2 quick & short beeps
service mode ok	1 quick & short beep
UPS initial starts up with self test	2 successive quick & short beeps, repeating per ~2 sec interval.

4.4.3. Battery Replacement

Step 1

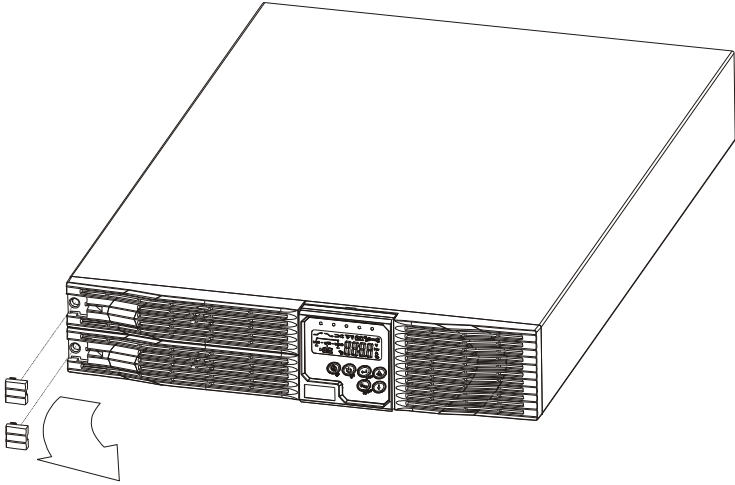
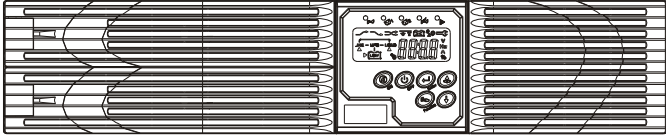

Step 2

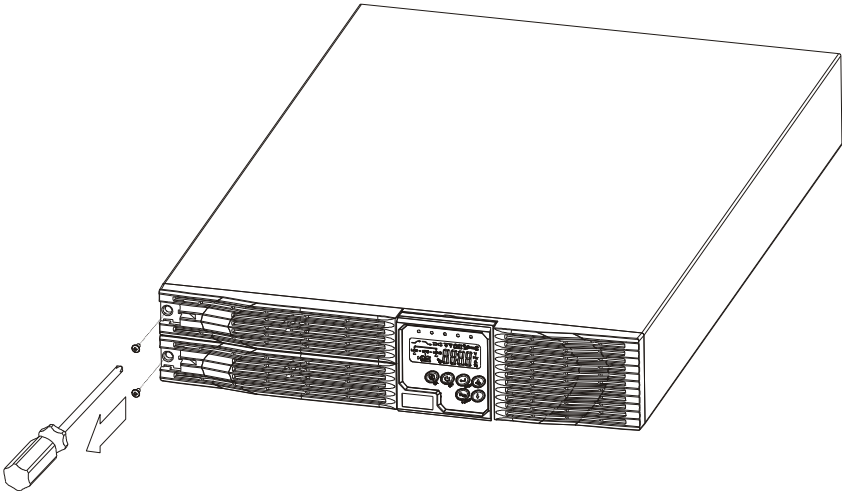

Step 3

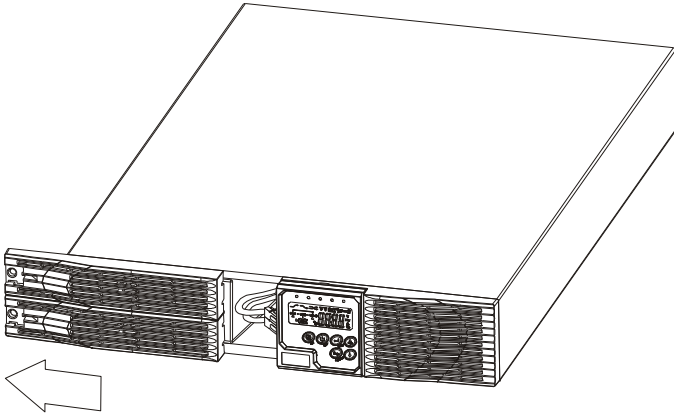

Step 4
1KVA

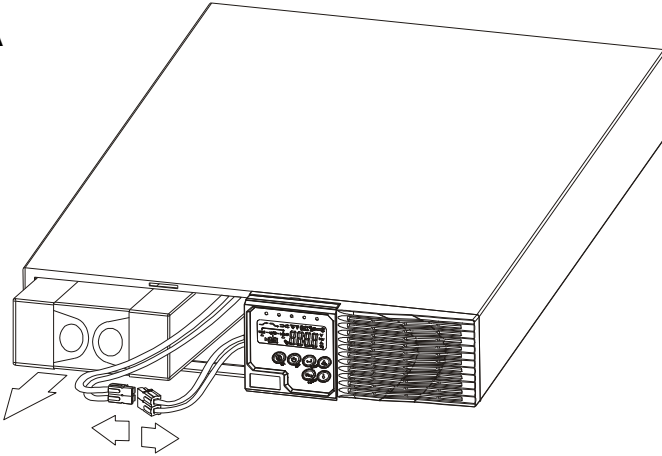

2K/3KVA

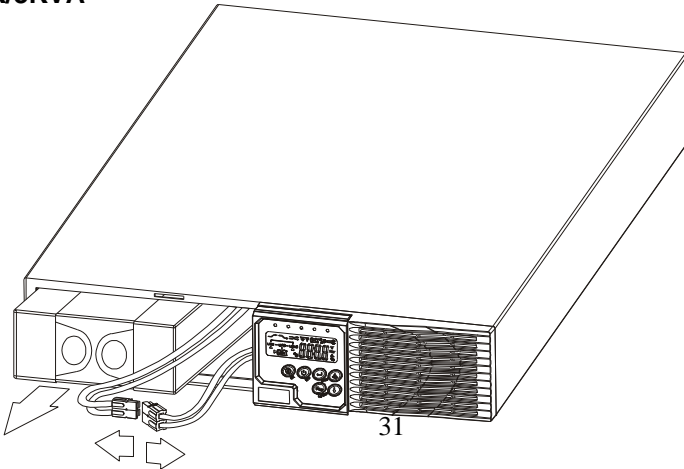

5. UPS Working Principle

5.1. UPS System Block Diagram

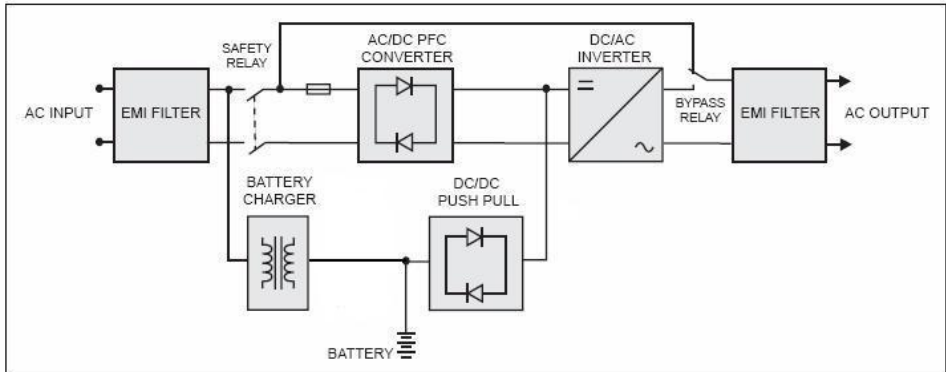

(fig 5.1)

Figure 5.1 above illustrates the True On-Line Double Conversion architecture of the UPS system. The major modules consist of :

- 1) An AC to DC power converter (Rectifier) with PFC control circuit
- 2) A DC to AC power high frequency inverter
- 3) An Intelligent Battery Charger
- 4) A bank of stationary maintenance-free batteries
- 5) A DC to DC push/pull converter control circuit
- 6) A Static Bypass Loop
- 7) Input & Output EMI Filter

The table below provide a summery guide to the UPS operating modes against the Utility AC Power Source conditions

Utility Conditions	UPS Operating Modes	LEDs Display indications
Utility Normal	Rectifier convert AC to DC, battery charging, Inverter convert DC to AC and supply to loads with clean & stable power.	~ , U ₁ , U ₂ LEDs remain illuminated
Utility Abnormal (under or over voltage) / Absent	Rectifier and charger stop operating , Battery discharge via DC~DC boost circuit and supply to Inverter. Loads continue to receive supply from Inverter. Alarm buzzer beeps, UPS now on battery mode.	~ LED off, U ₁ LED illuminated
Utility Abnormal/Absent, Battery low voltage	Rectifier and charger stop operating , Battery discharge via DC~DC boost circuit and supply to Inverter. Alarm buzzer beeps with quick & short succession, indicating battery power low and Inverter may stop supply soon.	~ LED off, U ₁ & U ₂ LED illuminated.

Paragraph 5.2 ~ 5.7 below provide detailed descriptions of the UPS operating principle

5.2. When Utility is Normal

The working principle of the UPS under Utility normal condition is illustrated as follows :

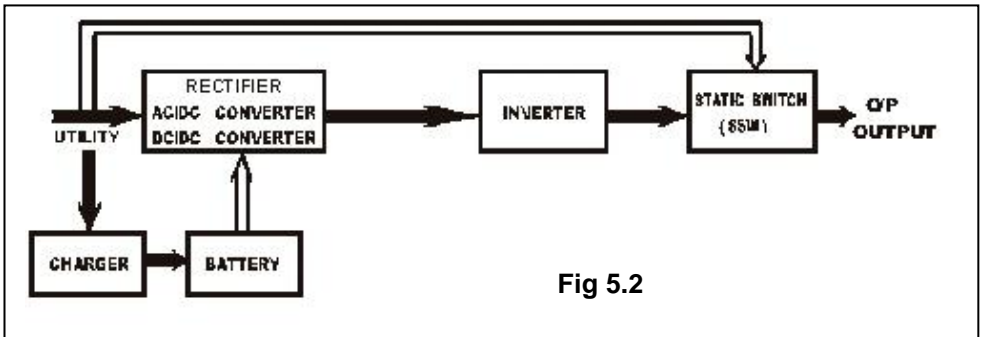

Fig 5.2

When Utility is normal, the AC source is rectified to DC, partially fed into the charger to charge battery and partially fed into inverter. The inverter reverts the DC to a cleaned and pure AC to supply energy to the load connected. The ~ , U₁, U₂ LEDs illuminated.

5.3. When Utility is Abnormal/Absent

The working principle of the UPS under Utility abnormal condition is illustrated as follows :

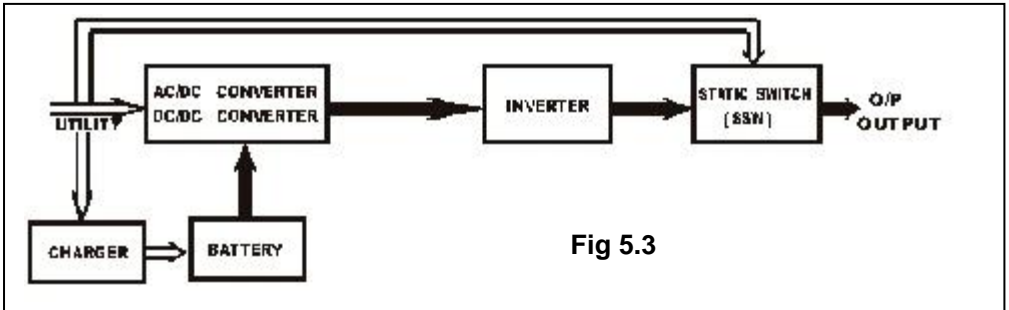



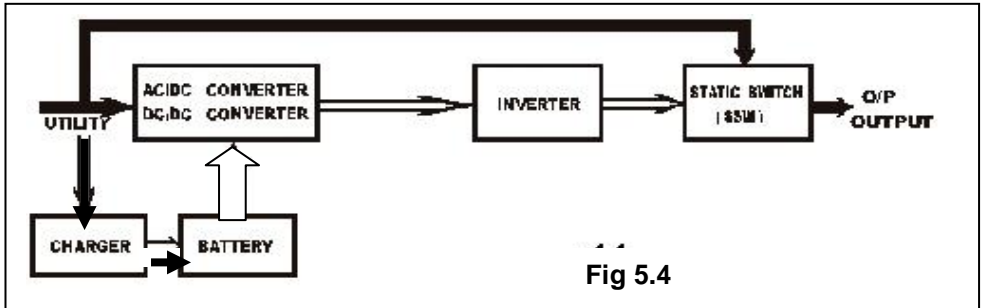

Fig 5.3

1. When Utility is abnormal, the UPS will direct the battery energy automatically to the Inverter without delay, and turn off the charger and AC/DC converter. The inverter revert DC to AC to supply energy to the output load connected without interruption. The  LED will be illuminated.
2. When Utility is back to Normal, the UPS will turn on the AC/DC converter, turn off DC/DC converter and switch the charger to charging mode. It has the same working principle as figure 5.2.
3. During a utility outage, the UPS will work as illustrated in figure 5.2. When Battery is low, buzzer will beep continuously till battery is completely cut off. The battery low protection of the UPS will cut off battery supply after a preset threshold to avoid the battery from over-drain. The  &  (Battery Low) LEDs will light up till the UPS is completely cut off. The UPS will re-start automatically when Utility is available.

5.4. Overload Condition

The working principle of the UPS when overloading is illustrated as follows :



1. Generally modern day electronics & IT equipment generate an inrush current when switching on. The amount of inrush current varies from equipment to equipment, some can be as high as 6 times its rated capacity while others produce negligible inrush. To prevent severe damage to its Inverter cause by the inrush produce by the loads, the UPS is equipped with electronics overload protection feature as standard. If the UPS loading is $>105\sim 120\%$ of its capacity, it will switch to bypass mode in 30 seconds to protect the Inverter. If overload condition is eliminated by reducing the load to $<105\%$, the UPS will switch back to Inverter mode automatically. If the UPS is over 150% loading, it inverter will shutdown immediately.
2. The UPS Bypass loop is also equipped with overload protection. Its overload capacity is illustrated by the graph & table below.

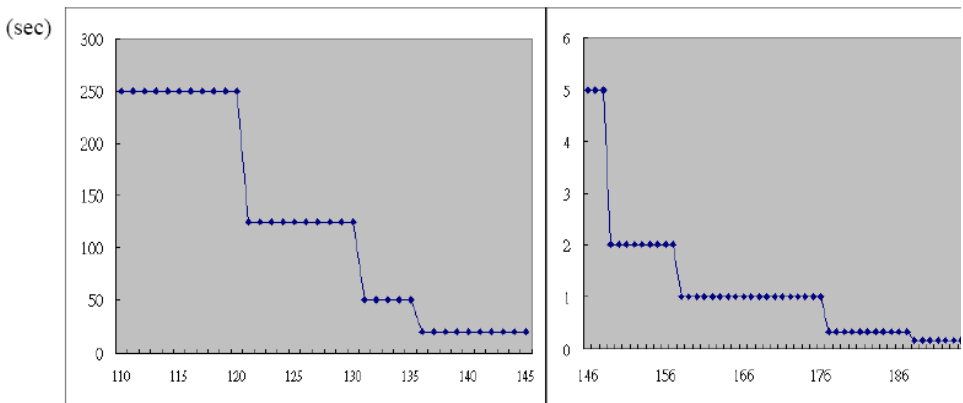

Load (%)	110~120	121~130	131~135	136~145	146~148	149~157	158~176	177~187	1
Delay Time (Sec)	250	125	50	20	5	2	1	0.32	

5.5. Inverter Failure

Output Load short circuit when supply via inverter

If output load is short circuited while supply via Inverter, the UPS will shutdown Inverter automatically and stop supply to the loads. The Fault LED lights up and the buzzer will beep continuously. The UPS will not switch on automatically after short circuit condition is eliminated. The UPS has to be re-start manually (refer to 4.5.1 'Start Up in Normal AC Mode').

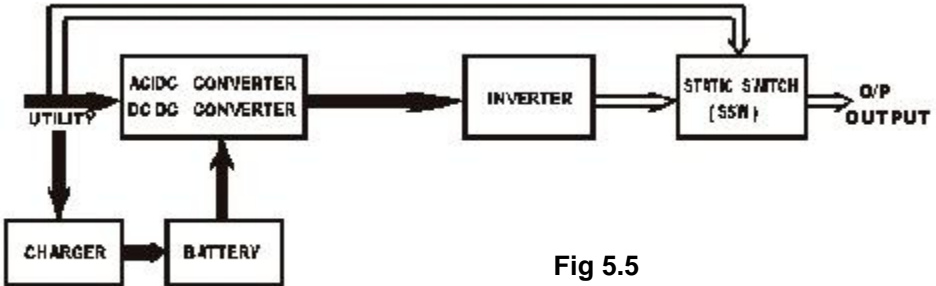

Fig 5.5

5.6. Inverter/Internal Over temperature

If the UPS experiences internal over-temperature when Utility is normal, it will switch to bypass loop. The UPS will switch back to inverter mode when the over-temperature situation is eliminated. If over temperature occurs when Utility is abnormal, the buzzer will beep continuously and the Fault LED \triangle will light up. The UPS will cut off supply to the loads.

5.7. Inverter Over

-current and Inverter Output Voltage Out of tolerance





If the UPS inverter delivers over-current and out-of-tolerance voltage to its outlets, the UPS is out of order. The UPS will switch to bypass loop when Utility is normal. The Utility \sim LED, Bypass \curvearrowright LED and Fault \triangle LED will light up.

If these two fault conditions occur when Utility is abnormal, the UPS will cut off the supply to its outlets and the Fault \triangle LED will light up.

6. Maintenance Guide

6.1. Trouble Shooting

When the UPS becomes faulty or malfunctions during operation, you may check the fault lists below for respective solutions. Should the problem persists, please contact your local dealer for assistance.

Situation	Check Items	Solution
<p>UPS Fault  LED</p> <p>Read the error code (see next page for error readings) displayed by the combinations of the LEDs and verify the fault as follow:</p>	<p>1. Er05, Er25, </p> <p>2. Overload </p> <p>3. Er11 (UPS Over Temperature)</p> <p>4. Site wiring/Ground fault </p> <p>5. Er14 (Fans out of order)</p> <p>6. Other error codes</p>	<p>1. Check battery connection if is properly done. Measure Battery voltage to ensure batteries are charged or healthy. Recharge batteries for 8 hours if necessary. Simulate Utility outage to verify if UPS is able to provide DC back-up. Otherwise consult your local dealer right away.</p> <p>2. Disconnect some non critical loads form the UPS output until overload ceases. Check if there is any short circuit between cables due to broken cable insulator. Replace the cables in necessary.</p> <p>3. Remove any objects obstructing the ventilation louvers. Verify if the cooling fans are working properly. Contacts your local dealer to replace the fans if necessary.</p> <p>4. Verify if the “L” & “N” phase of the Utility AC source has been wrongly wired or if the Ground-Neutral Voltage exceeded the limits</p> <p>5. Verify if the ventilating fans are functioning properly. Do not attempt to replace the fans by yourself. Contact your local dealer for replacement.</p> <p>6. Consult your local dealer for assistance.</p>

UPS fails to provide battery backup or its back up time is shorter than its intended performance.		If the backup time remains non-satisfactory after 8 hours of charging, please contact your local dealer for battery replacement.
UPS is normal but no Output to load	Check if all power codes are properly connected.	If problem persist, consult your local dealer for technical assistance.
The UPS switches to battery mode then back to Utility mode, when connected device is turned on. Or, the UPS switches back and forth between battery and Utility.	1.if any power strip is connected to the UPS. 2. Verify if there is any damage to the utility Wall Receptacle or if the cable cord plug is faulty.	1. Do not use power strip. 2. Replace the wall receptacle/cable cord plug.
Strange noise and smell		Immediately shut down the whole System. Disconnect the power from the UPS and call for service.
UPS is unable to provide backup power source		Check that the battery connectors are fully engaged. Allow the battery to recharge if the batter is weak. If problem persist after recharging, replace the battery. If problem persist, consult your local dealer for technical assistance.

6.2. **Error Codes and Their Descriptions**

Code	Descriptions
Er05	Battery weak or faulty
Er06	Output short-circuited
Er07	EPO mode
Er11	UPS over-temperature
Er12	Inverter overload
Er14	Fans out of order
Er18	EEPROM's data error
Er24	Utility Low (<85/170V) & Battery Disconnect
Er28	Bypass overload
Er31	EEPROM's data not conform to the Jumper Setting

6.3. **Maintenance**

Clean the dust from the ventilation openings and intakes on the rear panel.

1. Turn off the UPS and wipe the casing with a damp cloth.
2. Periodically unplug the power cord of the UPS from the wall Receptacle to test the batteries condition.
3. Be sure you have already saved your application before you proceed the battery discharging capability test.

7. Bundle Software Installation Guide

7.1. Hardware Installation

1. Connect the male connector of RS232/USB* cable to the UPS communication port.
2. Connect the female connector of the RS232/USB* cable to a dedicated RS232 port of the Computer.
3. For optional interface cards, please refer to Chapter 8 for more details.

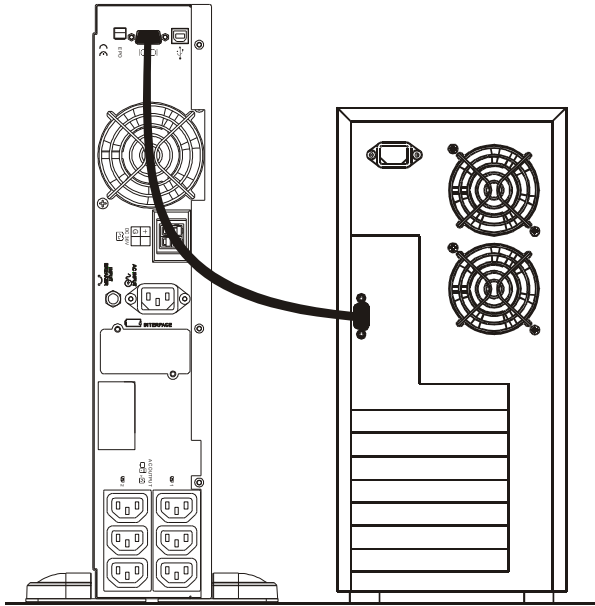

***Note: Only RS232 cable is provided with the UPS. USB cable is optional**

7.2. Software Installation

Please refer to the user's manual of the bundled software CD_ROM for installation guide.

8. Optional Communication Cards

8.1. R2E (2nd RS-232) card



8.1.1. CN1 is for RS232 DB9.

8.1.2. For communication protocol, please refer to Chapter 3.4.1.

8.1.3. Installation Position: Optional Slot.

8.2. USE (USB) card



8.2.1. CN1 is for USB.

8.2.2. For communication protocol, please refer to Chapter 3.4.2

8.2.3. Installation Position: Optional Slot

8.3. DCE (Dry Contact) card

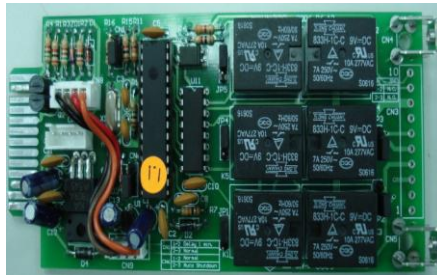

8.3.1. The pin assignments of 10-Pin Terminal :

1	2	3	4	4	5	6	7	8	9	10
---	---	---	---	---	---	---	---	---	---	----

- 1 → UPS on Bypass mode (Bypass)
- 2 → Utility Normal (Normal close contact)
- 3 → Utility Normal (Normal open contact)
- 4 → Inverter On
- 5 → Battery Low
- 6 → Battery Bad or abnormal
- 7 → UPS Alarm
- 8 → Common
- 9 → Shutdown UPS positive(+) signal
- 10 → Shutdown UPS negative(-) signal

8.3.2. The shutdown function will be activated, after a +6~+25Vdc is put between pin 9 and pin 10 for 5 seconds.

8.3.3. The capacity of each relay contact is 40Vdc/25mA.

8.3.4. Installation Position : Optional Slot.

8.3.5. Flexible signal output for N.C.(Normal Close) or N.O.(Normal Open) contact by shorting pin1-2 or pin2-3 form JP1-5.

8.3.6. The shutdown function will be enabled in 1 minute after blackout occurs if the pin1-2 of both CN1 and CN6 are shorted by cap. Or, the shutdown function can only be enabled by pin9-10 of CN3 if the pin2-3 of both CN1 and CN6 are shorted by cap.

8.4. SNMP Cards

8.4.1. SNMP card of Megatec



8.4.2.1 For installation, please refer to the user's manual attached with the card.

8.4.2.2 Installation Position : Optional Slot

9. Specifications

Model		1KVA	2KVA	3KVA
VA Rating				
Apparent Output Power		1000 VA	2000 VA	3000 VA
Active Output Power		800 Watts	1600 Watts	2400 Watts
Power Factor		0.8		
Topology		Double conversion On-Line		
Type		Rack/Tower		
Agency Approvals		CE		
Input				
Voltage Window		160 – 288 Vac		
Frequency		50/60 Hz auto-select, \pm 5Hz		
Phase		Single phase with ground		
PF		> 0.99 at full rated linear load		
Typical Transfer Time		0 ms.		
AC Leakage current		\leq 3.5 mA		
Surge Protection		300 joules		
Output				
Output (INV. mode)	Voltage	230V, adjustable to 200/208/220/230/240		
	Voltage Regulation	$\leq \pm$ 1% until low battery warning		
	Frequency(Synchronized Range)	3Hz or 1Hz (setting by software)		
	Frequency(Battery Mode)	\pm 0.1% (0.05~0.06Hz) unless synchronized to line		
	Current Crest Factor	3:1		
	Harmonic Distortion	\leq 3% THD(Linear Load)		
	Transient Response(ms)	< = 60ms/5%		
	Waveform	Pure Sine wave		
Efficiency	To AC Mode (Full load)	85%	85%	88%
	To Battery Mode (Full load)	83%	83%	85%
Battery System				

Type	12V/7.2Ah	12V/7.2Ah	12V/9Ah
Numbers of Batteries	3	6	6
Backup Time(Full Load)	>7min.	>7min.	>5min.
Recharging Time	4 Hours to 90%		
Charging Current (Max.)	1.1A	2.16A	2.7A
Charging Voltage	41.0Vdc±0.5V	82.0Vdc±0.5V	82.0Vdc±0.5V
Hot Swappable Battery	Yes		
Internal battery	Yes		
DC leakage current	≤ 30uA (±10uA) with no AC applied and the unit in the off position		
Battery type	Sealed, non-spillage, maintenance-free, lead acid		
Transfer Time			
AC to DC	Zero		
Inverter to Bypass	2.5ms(Typical)	Zero	
DC Start	Yes		
Self Diagnostics	By button of the panel or Software Control		
Front Panel			
LED	Load Level/Battery Level/ Battery Mode/ Normal Mode/Bypass Mode/ Self-Test/ Weak/Bad Battery/Site Wiring Fault/ Fault/ Overload/Programmable Outlet 1//Programmable Outlet 2		
Key	ON Button/ OFF Button/ (Test/Alarm Reset Button)		
Protection			
Overload	(AC or BATTERY Mode) < 105% continuous > 106% ~ 120% for 30 seconds transfer to bypass > 121% ~ 150% for 10 seconds transfer to bypass > 150% for immediately transfer to bypass Buzzer continuously alarms.		
Short Circuit	Bypass mode : Input Fuse/Input Breaker Normal Mode: Output Breaker/Electronic Circuit Battery Mode: Output Breaker/Electronic Circuit		
Battery	ABDM		
EPO	UPS shuts down immediately		
Over Temperature	Normal Mode	Transfer to Bypass Mode	
	Battery Mode	UPS shuts down immediately	
Audible Alarm			
Battery Mode	Sounding once every 1.5 seconds		

Low Battery	Sounding once every 0.2 seconds		
Overload	Sounding once every 3 second		
Fault	Continuously Sounding (or Sounding once every 3 second)		
Physical			
Dimensions(HxWxD in mm)	88(2U)x440x405	88(2U)x440x 650	88(2U)x440x 650
Weights	15.7kg	29.4kg	29.7kg
Input Connection	10A, IEC 320-C14	10A, IEC 320-C14	16A, IEC 320-C20
Output Connection	(6) 10A,IEC 320-C13		(4) 10A,IEC 320-C13 (1) 16A,IEC 320-C19
Environmental			
Operation Temperature	0-40		
Noise Level	< 50dBA		
Relative Humidity	0 to 90% (Wwithout condensation)		
Interface			
Interface Type	1 *USB port+ 1*RS-232 port		
SNMP(option)	Power management from SNMP manager and Web browser		
Compatible platforms	Windows 95/98/NT/2000/XP Novell NetWare, Linux, etc.		
Standards and Certification			
Safety	IEC/EN 62040-1-1,IEC 60950-1		
Performance	IEC/EN 62040-3		
EMC	IEC/EN62040-2 Class A, FCC Part 15 Subpart B Class A,		
Markings	CE		



192321132025004