



**Powerware® 9125 Two-in-One UPS
5000/6000 VA
User's Guide**

Class A EMC Statements

FCC Part 15

NOTE This equipment has been tested and found to comply with the limits for a Class A digital device, pursuant to part 15 of the FCC Rules. These limits are designed to provide reasonable protection against harmful interference when the equipment is operated in a commercial environment. This equipment generates, uses, and can radiate radio frequency energy and, if not installed and used in accordance with the instruction manual, may cause harmful interference to radio communications. Operation of this equipment in a residential area is likely to cause harmful interference in which case the user will be required to correct the interference at his own expense.

ICES-003

This Class A Interference Causing Equipment meets all requirements of the Canadian Interference Causing Equipment Regulations ICES-003.

Cet appareil numérique de la classe A respecte toutes les exigences du Règlement sur le matériel brouilleur du Canada.

EN 50091-2

Some configurations are classified under EN 50091-2 as "Class-A UPS for Unrestricted Sales Distribution." For these configurations, the following applies:

WARNING This is a Class A-UPS Product. In a domestic environment, this product may cause radio interference, in which case, the user may be required to take additional measures.

Powerware, ABM, and FERRUPS are registered trademarks and X-Slot, ConnectUPS, and LanSafe are trademarks of Eaton Power Quality Corporation. Greenlee is a registered trademark of Greenlee Textron. Modbus is a registered trademark of Modicon.

©Copyright 2003–2005 Eaton Corporation, Raleigh, NC, USA. All rights reserved. No part of this document may be reproduced in any way without the express written approval of Eaton Corporation.

Requesting a Declaration of Conformity

Units that are labeled with a CE mark comply with the following harmonized standards and EU directives:

- Harmonized Standards: EN 50091-1-1 and EN 50091-2; IEC 60950 Third Edition
- EU Directives: 73/23/EEC, Council Directive on equipment designed for use within certain voltage limits
93/68/EEC, Amending Directive 73/23/EEC
89/336/EEC, Council Directive relating to electromagnetic compatibility
92/31/EEC, Amending Directive 89/336/EEC relating to EMC

The EC Declaration of Conformity is available upon request for products with a CE mark. For copies of the EC Declaration of Conformity, contact:

Eaton Power Quality Oy
Koskelontie 13
FIN-02920 Espoo
Finland
Phone: +358-9-452 661
Fax: +358-9-452 665 68

Special Symbols

The following are examples of symbols used on the UPS or accessories to alert you to important information:



RISK OF ELECTRIC SHOCK - Indicates that a risk of electric shock is present and the associated warning should be observed.



CAUTION: REFER TO OPERATOR'S MANUAL - Refer to your operator's manual for additional information, such as important operating and maintenance instructions.



This symbol indicates that you should not discard the UPS or the UPS batteries in the trash. This product contains sealed, lead-acid batteries and must be disposed of properly. For more information, contact your local recycling/reuse or hazardous waste center.

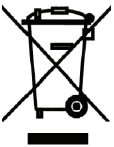

This symbol indicates that you should not discard waste electrical or electronic equipment (WEEE) in the trash. For proper disposal, contact your local recycling/reuse or hazardous waste center.

Table of Contents

- 1 Introduction 1**
- 2 Safety Warnings 3**
- 3 Installation 15**
 - Inspecting the Equipment 15
 - UPS Setup 15
 - Installing the UPS Internal Batteries 16
 - Tower Setup 17
 - EBM Installation 19
 - Plug-Receptacle UPS Installation 21
 - Remote Emergency Power-off Installation 22
 - Hardwired UPS Installation 24
- 4 Operation 29**
 - Turning the UPS On 29
 - Starting the UPS on Battery 29
 - Turning the UPS Off 30
 - Initiating the Battery Test 30
 - Transferring the UPS to Bypass Mode 31
 - Operating Modes 31
 - Normal Mode 32
 - Battery Mode 33
 - Bypass Mode 34
 - Standby Mode 34
- 5 Configuration 35**
- 6 Communication 37**
 - USB Port 37
 - DB-9 Communication Port 38
 - X-Slot Cards 39
- 7 UPS Maintenance 41**
 - UPS and Battery Care 41
 - Storing the UPS and Batteries 41
 - When to Replace Batteries 41

TABLE OF CONTENTS

Replacing Batteries	42
How to Replace Extended Battery Modules	42
How to Replace Internal Batteries	44
Testing New Batteries	45
Recycling the Used Battery or UPS	46
8 Specifications	47
9 Troubleshooting	51
Audible Alarms and UPS Conditions	51
Silencing an Audible Alarm	51
Service and Support	54
10 Warranty	55
Two-Year Limited Warranty (US and Canada)	55
Ten-Year Pro-Rated Limited Warranty (US and Canada)	57
Load Protection Guarantee (US and Canada)	59

Chapter 1 Introduction

The Powerware® 9125 uninterruptible power system (UPS) protects your sensitive electronic equipment from the most common power problems including power failures, power sags, power surges, brownouts, line noise, high voltage spikes, frequency variations, switching transients, and harmonic distortion.

Power outages can occur when you least expect it and power quality can be erratic. These power problems have the potential to corrupt critical data, destroy unsaved work sessions, and damage hardware — causing hours of lost productivity and expensive repairs.

With the Powerware 9125, you can safely eliminate the effects of power disturbances and guard the integrity of your equipment. Figure 1 shows the Powerware 9125 UPS with an optional Extended Battery Module (EBM).

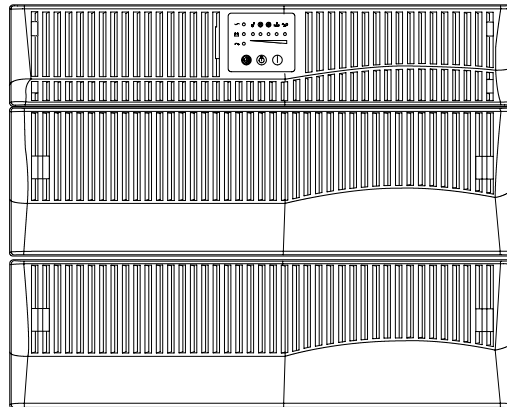

Figure 1. The Powerware 9125 UPS with Optional EBM

Providing outstanding performance and reliability, the Powerware 9125's unique benefits include the following:

- Online UPS design with pure sine wave output. The UPS filters and regulates incoming AC power and provides consistent power to your equipment without draining the battery.
- 5U rack height with the highest power density for a 6000 VA UPS.
- Two-in-one form factor for using the UPS in a rack-mount configuration or as a standalone cabinet.
- ABM® technology that uses advanced battery management to increase battery service life, optimize recharge time, and provide a warning before the end of useful battery life.
- Hours of extended runtime with up to four EBMs.
- Start-on-battery capability for powering up the UPS even if utility power is not available.
- Hot-swappable batteries that simplify maintenance by allowing you to replace batteries safely without powering down the critical load.
- Emergency shutdown control through the remote emergency power-off (REPO) port.
- Two standard communication options with a USB port and a DB-9 serial port.
- Optional X-Slot™ cards with enhanced communication capabilities for increased power protection and control.
- Advanced power management with the Software Suite CD for graceful shutdowns and power monitoring.
- Backed by worldwide agency approvals.

Chapter 2 Safety Warnings

IMPORTANT SAFETY INSTRUCTIONS SAVE THESE INSTRUCTIONS

This manual contains important instructions that you should follow during installation and maintenance of the UPS and batteries. Please read all instructions before operating the equipment and save this manual for future reference.

DANGER



This UPS contains **LETHAL VOLTAGES**. All repairs and service should be performed by **AUTHORIZED SERVICE PERSONNEL ONLY**. There are **NO USER SERVICEABLE PARTS** inside the UPS.

WARNING



- This UPS contains its own energy source (batteries). The output receptacles may carry live voltage even when the UPS is not connected to an AC supply.
 - For 208–240V models, the output receptacles may remain electrically live. If the input power source in your application is wired line-to-neutral (as in most European applications), the voltage to the output receptacles is 0V. With line-to-line input wiring, the voltage to the output receptacles is 110–120V (measured from line-to-ground or line-to-neutral, depending on the UPS wiring).
 - Do not remove or unplug the input cord when the UPS is turned on. This removes the safety ground from the UPS and the equipment connected to the UPS.
 - To reduce the risk of fire or electric shock, install this UPS in a temperature and humidity controlled, indoor environment, free of conductive contaminants. Ambient temperature must not exceed 40°C (104°F). Do not operate near water or excessive humidity (95% maximum).
 - For UPS models with hardwired outputs, overcurrent protection for the output AC circuit(s) is to be provided by others.
 - For UPS models with hardwired outputs, suitably rated disconnect switches for the output AC circuit(s) are to be provided by others.
-



CAUTION

- Batteries can present a risk of electrical shock or burn from high short-circuit current. Observe proper precautions. Servicing should be performed by qualified service personnel knowledgeable of batteries and required precautions. Keep unauthorized personnel away from batteries.
- Proper disposal of batteries is required. Refer to your local codes for disposal requirements.
- Never dispose of batteries in a fire. Batteries may explode when exposed to flame.

Sikkerhedsanvisninger

VIGTIGE SIKKERHEDSANVISNINGER GEM DISSE ANVISNINGER DENNE BRUGERVEJLEDNING INDEHOLDER VIGTIGE SIKKERHEDSANVISNINGER



FARE

Denne UPS indeholder LIVSFARLIG HØJSPÆNDING. Alle reparationer og vedligeholdelse bør kun udføres af en AUTORISERET SERVICE TEKNIKER. Ingen af UPS'ens indvendige dele kan repareres af brugeren.



ADVARSEL!

- Denne UPS indeholder egen energiforsyning (batterier). Udgangsnetstikkene kan lede strøm, selv når UPS'en ikke er tilsat en AC-energikilde.
- Netledningen må ikke fjernes og stikket må ikke trækkes ud, mens UPS'en er tændt. Dette fjerner sikkerhedsjorden fra UPS'en og fra det udstyr, der er sat til.
- Installer denne UPS i et temperatur- og fugtighedskontrolleret indendørsmiljø, frit for ledende forureningsstoffer for at formindske risikoen for brand og elektrisk stød. Rumtemperaturen må ikke overstige 40°C. UPS'en bør ikke betjenes nær vand eller høj fugtighed (maksimalt 95%).
- For UPS systemer med hårdledningsudgange, skal overstrømsbeskyttelse for vekslestrømmens udgangskredsløb forsynes af andre.
- For UPS systemer med hårdledningsudgange, skal egnede, nominelle afbryderkontakter for vekslestrømmens udgangskredsløb forsynes af andre.



ADVARSEL

- Batterier kan udgøre en fare for elektrisk stød eller forbrændinger forårsaget af høj kortslutningsspænding. De korrekte forholdsregler bør overholdes.
- Korrekt bortskaffelse af batterier er påkrævet. Overhold gældende lokale regler for bortskaffelsesprocedurer.
- Skaf dig aldrig af med batterierne ved at brænde dem. Batterierne kan eksplodere ved åben ild.

Belangrijke Veiligheidsinstructies

BELANGRIJKE VEILIGHEIDSINSTRUCTIES BEWAAR DEZE INSTRUCTIES DEZE HANDLEIDING BEVAT BELANGRIJKE VEILIGHEIDSINSTRUCTIES



GEVAAR

Deze UPS bevat LEVENSGEVAARLIJKE ELEKTRISCHE SPANNING. Alle reparaties en onderhoud dienen UITSLUITEND DOOR ERKEND SERVICEPERSONEEL te worden uitgevoerd. Er bevinden zich GEEN ONDERDELEN in de UPS die DOOR DE GEBRUIKER kunnen worden GEREPAREERD.



WAARSCHUWING

- Deze UPS bevat zijn eigen energiebron (batterijen). De uitgangsaansluitingen kunnen onder spanning staan wanneer de UPS niet op een wisselstroom voeding is aangesloten.
- Verwijder de ingang snoer niet of haal de stekker van de ingang snoer er niet uit terwijl de UPS aan staat. Hierdoor zou de UPS en uw aangesloten apparatuur geen aardebeveiliging meer hebben.
- Teneinde de kans op brand of elektrische schok te verminderen dient deze UPS in een gebouw met temperatuur- en vochtigheidsregeling te worden geïnstalleerd, waar geen geleidende verontreinigingen aanwezig zijn. De omgevingstemperatuur mag 40°C niet overschrijden. Niet gebruiken in de buurt van water of bij zeer hoge vochtigheid (max. 95%).
- Voor UPS systemen met vast-bedrade uitgangen, moet de overstroombeveiliging voor wisselstroom uitvoercircuit(s) door anderen worden geleverd.
- Voor UPS systemen met vast-bedrade uitgangen, moeten de juiste hoofdschakelaars voor wisselstroom uitvoercircuit(s) door anderen worden geleverd.



OPGELET

- Batterijen kunnen gevaar voor elektrische schok of brandwonden veroorzaken als gevolg van un hoge kortsluitstroom. Volg de desbetreffende aanwijzingen op.
- De batterijen moeten op de juiste wijze worden opgeruimd. Raadpleeg hiervoor uw plaatselijke voorschriften.
- Nooit batterijen in het vuur gooien. De batterijen kunnen ontploffen.

Tarkeita Turvaohjeita

TÄRKEITÄ TURVAOHJEITA - SUOMI SÄILYTÄ NÄMÄ OHJEET TÄMÄ OPAS SISÄLTÄÄ TÄRKEITÄ TURVAOHJEITA



VAARA

Tämä UPS sisältää HENGENVAARALLISIA JÄNNITTEITÄ. Kaikki korjaukset ja huollot on jätettävä VAIN VALTUUTETUN HUOLTOHENKILÖN TOIMEKSI. UPS ei sisällä MITÄÄN KÄYTTÄJÄN HUOLLETTAVIA OSIA.



VAROITUS

- Tämä UPS sisältää oman energialähteen (akuston). Ulostuloliittimissä voi olla jännite, kun UPS ei ole liitettyä verkkojännitteeseen.
- Älä poista tai irrota sisääntulojohtoa, kun UPS on kytkettynä. Tämä poistaa turvamaadoituksen UPS-laitteesta ja siihen liitetystä laitteistosta.
- Vähentääksesi tulipalon ja sähköiskun vaaraa asenna tämä UPS sisätiloihin, joissa lämpötila ja kosteus on säädettävissä ja joissa ei ole virtaa johtavia epäpuhtauksia. Ympäristön lämpötila ei saa ylittää 40 °C. Älä käytä lähellä vettä ja vältä kosteita tiloja (95 % maksimi).
- UPS-järjestelmissä kiintealla asennuksella: kuormana olevien laitteiden ylivirtasuojaus ja erotuskytkimet tulee toteuttaa kuormapiireissa.



VARO

- Akusto saattaa aiheuttaa sähköiskun tai syttyä tuleen, jos akusto kytketään oikosulkuun. Noudata asianmukaisia ohjeita.
- Akusto täytyy hävittää säädösten mukaisella tavalla. Noudata paikallisia määräyksiä.
- Älä koskaan heitä akkuja tuleen. Ne voivat räjähtää.

Consignes de sécurité

CONSIGNES DE SÉCURITÉ IMPORTANTES CONSERVER CES INSTRUCTIONS CE MANUEL CONTIENT DES CONSIGNES DE SÉCURITÉ IMPORTANTES



DANGER!

Cet onduleur contient des TENSIONS MORTELLES. Toute opération d'entretien et de réparation doit être EXCLUSIVEMENT CONFIEE A UN PERSONNEL QUALIFIE AGRÉÉ. AUCUNE PIÈCE RÉPARABLE PAR L'UTILISATEUR ne se trouve dans l'onduleur.



AVERTISSEMENT!

- Cet onduleur renferme sa propre source d'énergie (batteries). Les prises de sortie peuvent être sous tension même lorsque l'onduleur n'est pas branché sur le secteur.
- Ne pas retirer le cordon d'alimentation lorsque l'onduleur est sous tension sous peine de supprimer la mise à la terre de l'onduleur et du matériel connecté.
- Pour réduire les risques d'incendie et de décharge électrique, installer l'onduleur uniquement à l'intérieur, dans un lieu dépourvu de matériaux conducteurs, où la température et l'humidité ambiantes sont contrôlées. La température ambiante ne doit pas dépasser 40 °C. Ne pas utiliser à proximité d'eau ou dans une atmosphère excessivement humide (95 % maximum).
- Pour les modèles UPS ayant des sorties câblées, la protection contre une surintensité pour le(s) circuit(s) de sortie de courant alternatif doit être fournie par un autre fournisseur.
- Pour les modèles UPS ayant des sorties câblées, les interrupteurs de déconnexion convenables pour le(s) circuit(s) de sortie de courant alternatif doivent être fournis par un autre fournisseur.



ATTENTION!

- Les batteries peuvent présenter un risque de décharge électrique ou de brûlure par des courts-circuits de haute intensité. Prendre les précautions nécessaires.
- Une mise au rebut réglementaire des batteries est obligatoire. Consulter les règlements en vigueur dans votre localité.
- Ne jamais jeter les batteries au feu. L'exposition aux flammes risque de les faire exploser.

Sicherheitswarnungen

WICHTIGE SICHERHEITSANWEISUNGEN AUFBEWAHREN. DIESES HANDBUCH ENTHÄLT WICHTIGE SICHERHEITSANWEISUNGEN.

WARNUNG



Die USV führt lebensgefährliche Spannungen. Alle Reparatur- und Wartungsarbeiten sollten nur von Kundendienstfachleuten durchgeführt werden. Die USV enthält keine vom Benutzer zu wartenden Komponente.

ACHTUNG



- Diese USV ist mit einer eigenen Energiequelle (Batterie) ausgestattet. An den Ausgangssteckdosen kann auch dann Spannung anliegen, wenn die USV nicht an einer Wechselspannungsquelle angeschlossen ist.
- Das Eingangskabel nicht entfernen oder abziehen, während die USV eingeschaltet ist, weil hierdurch die Sicherheitserdung von der USV und den daran angeschlossenen Geräten entfernt wird.
- Um die Brand- oder Elektroschockgefahr zu verringern, diese USV nur in Gebäuden mit kontrollierter Temperatur und Luftfeuchtigkeit installieren, in denen keine leitenden Schmutzstoffen vorhanden sind. Die Umgebungstemperatur darf 40°C nicht übersteigen. Die USV nicht in der Nähe von Wasser oder in extrem hoher Luftfeuchtigkeit (max. 95 %) betreiben.
- Für UPS-Systeme mit festverdrahteten Eingängen muß der Überstromschutz für die Ausgangswechselstromkreise anderweitig bereitgestellt werden.
- Für UPS-Systeme mit festverdrahteten Ausgängen müssen Trennschalter für die Ausgangswechselstromkreise mit passendem Nennwert anderweitig bereitgestellt werden.

VORSICHT!



- Batterien können aufgrund des hohen Kurzschlußstroms Elektroschocks oder Verbrennungen verursachen. Die entsprechenden Vorsichtsmaßnahmen sind unbedingt zu beachten.
- Die Batterien müssen ordnungsgemäß entsorgt werden. Hierbei sind die örtlichen Bestimmungen zu beachten.
- Batterien niemals verbrennen, da sie explodieren können.

Avvisi di sicurezza

IMPORTANTI ISTRUZIONI DI SICUREZZA CONSERVARE QUESTE ISTRUZIONI QUESTO MANUALE CONTIENE IMPORTANTI ISTRUZIONI DI SICUREZZA



PERICOLO

la TENSIONE contenuta in questo gruppo statico di continuità è LETALE. Tutte le operazioni di riparazione e di manutenzione devono essere effettuate ESCLUSIVAMENTE DA PERSONALE TECNICO AUTORIZZATO. All'interno del gruppo statico di continuità NON vi sono PARTI RIPARABILI DALL'UTENTE.



AVVERTENZA

- Questo gruppo statico di continuità contiene una fonte di energia autonoma (le batterie). Le prese di uscita possono condurre tensione energizzata quando il gruppo statico di continuità non è collegato con una fonte di alimentazione a corrente alternata.
- Non rimuovere nè scollegare il cavo di ingresso quando il gruppo statico di continuità è acceso poichè in tal modo si disattiverebbe il collegamento a terra di sicurezza del gruppo statico di continuità e dell'apparecchiatura ad esso collegata.
- Per ridurre il rischio di incendio o di scossa elettrica, installare il gruppo statico di continuità in un ambiente interno a temperatura ed umidità controllata, privo di agenti contaminanti conduttivi. La temperatura ambiente non deve superare i 40°C. Non utilizzare l'unità in prossimità di acqua o in presenza di umidità eccessiva (95% max).
- Nei sistemi UPS provvisti di uscite cablate, i dispositivi di protezione da sovracorrente per il/i circuito/i a corrente alternata in uscita devono essere forniti da terzi.
- Nei sistemi UPS provvisti di uscite cablate, i sezionatori di corrente nominale adeguata per il/i circuito/i a corrente alternata in uscita devono essere forniti da terzi.



ATTENZIONE

- Le batterie possono presentare rischio di scossa elettrica o di ustioni provocate da alta corrente dovuta a corto circuito. Osservare le apposite istruzioni.
- Le batterie devono essere smaltite in modo corretto. Per i requisiti di smaltimento fare riferimento alle disposizioni locali.
- Non gettare mai le batterie nel fuoco poichè potrebbero esplodere se esposte alle fiamme.

Viktig Sikkerhetsinformasjon



FARLIG

Denne UPS'en inneholder LIVSFARLIGE SPENNINGER. All reparasjon og service må kun utføres av AUTORISERT SERVICEPERSONALE. BRUKERE KAN IKKE UTFØRE SERVICE PÅ NOEN AV DELENE i UPS'en.



FARLIG

- Denne UPS'en har en egen energikilde (batterier). Stikkontaktene kan være strømførende selv om UPS'en ikke er tilsluttet en vekselstrømforsyning.
- Strømforsyningskabelen må ikke fjernes eller trekkes ut når UPS'en er på, slik at ikke sikkerhetsjordingen fjernes fra UPS'en og det utstyret som er forbundet med den.
- For å redusere fare for brann eller elektriske støt, bør denne UPS'en installeres i et innendørs miljø med kontrollert temperatur og luftfuktighet som er fritt for ledende, forurensende stoffer. Romtemperaturen må ikke overskride 40°C. Den må ikke brukes i nærheten av vann eller ved meget høy luftfuktighet (95% maks.).
- For UPS systemer med fastkoplede uttak, må overstrømvern for vekselstrømuttak(ene) stilles til rådighet av andre.
- For UPS systemer med fastkoplede uttak, må passende utkoplingsbrytere for vekselstrømuttak(ene) stilles til rådighet av andre.



FORSIKTIG

- Batterier kan forårsake elektriske støt eller forbrenning på grunn av høy kortslutningsstrøm. Følg instruksene.
- Batterier må fjernes på korrekt måte. Se lokale forskrifter vedrørende krav om fjerning av batterier.
- Kast aldri batterier i flammer, da de kan eksplodere, hvis de utsettes for åpen ild.

Regulamentos de Segurança

INSTRUÇÕES DE SEGURANÇA IMPORTANTES GUARDE ESTAS INSTRUÇÕES ESTE MANUAL CONTÉM INSTRUÇÕES DE SEGURANÇA IMPORTANTES



CUIDADO

A UPS contém VOLTAGEM MORTAL. Todos os reparos e assistência técnica devem ser executados **SOMENTE POR PESSOAL DA ASSISTÊNCIA TÉCNICA AUTORIZADO**. Não há nenhuma PEÇA QUE POSSA SER REPARADA PELO USUÁRIO dentro da UPS.



ADVERTÊNCIA

- Esta UPS contém sua própria fonte de energia (baterias). Os receptáculos de saída podem conter voltagem ativa quando a UPS não se encontra conectada a uma fonte de alimentação de corrente alternada.
- Não remova ou desconecte o cabo de entrada quando a UPS estiver ligada. Isto removerá o aterramento de segurança da UPS e do equipamento conectado.
- Para reduzir o risco de incêndios ou choques elétricos, instale a UPS em ambiente interno com temperatura e umidade controladas e livres de contaminadores condutíveis. A temperatura ambiente não deve exceder 40°C. Não opere próximo a água ou em umidade excessiva (máx: 95%).
- Para sistemas UPS com saídas conectadas, a proteção de sobrecarga para circuitos de saída de corrente alternada deve ser fornecida por outros.
- Para sistemas UPS com saídas conectadas, interruptores de desconexão devidamente qualificados para circuitos de saída de corrente alternada devem ser fornecidos por outros.



PERIGO

- As baterias podem apresentar o risco de choque elétrico, ou queimaduras provenientes de alta corrente de curto-circuito. Observe as instruções adequadas.
- Siga as instruções apropriadas ao desfazer-se das baterias. Consulte os códigos do local para maiores informações sobre os regulamentos de descarte de produtos.
- Nunca jogue as baterias no fogo, porque há risco de explosão.

Предупреждения по мерам безопасности

**ВАЖНЫЕ УКАЗАНИЯ ПО МЕРАМ БЕЗОПАСНОСТИ
СОХРАНИТЕ ЭТИ УКАЗАНИЯ
ДАННОЕ РУКОВОДСТВО СОДЕРЖИТ ВАЖНЫЕ
УКАЗАНИЯ ПО МЕРАМ БЕЗОПАСНОСТИ**

ОПАСНО



В данном ИБП имеются СМЕРТЕЛЬНО ОПАСНЫЕ НАПРЯЖЕНИЯ. Все работы по ремонту и обслуживанию должны выполняться ТОЛЬКО УПОЛНОМОЧЕННЫМ ОБСЛУЖИВАЮЩИМ ПЕРСОНАЛОМ. Внутри ИБП нет узлов, ОБСЛУЖИВАЕМЫХ ПОЛЬЗОВАТЕЛЕМ.

ПРЕДУПРЕЖДЕНИЕ



- Данный ИБП содержит собственные источники энергии (аккумуляторы). На выходных розетках может иметься напряжение, даже когда ИБП не подключен к сети переменного тока.
- Не отсоединяйте сетевой шнур и не извлекайте его вилку из розетки при включенном ИБП. При этом защитное заземление отключается от ИБП и от оборудования, подключенного к ИБП.
- Для снижения опасности пожара или поражения электрическим током устанавливайте ИБП в закрытом помещении с контролируемой температурой и влажностью, в котором отсутствуют проводящие загрязняющие вещества. Температура окружающего воздуха не должна превышать 40°C. Не эксплуатируйте устройство около воды или в местах с повышенной влажностью (макс. 95%).

ОСТОРОЖНО



- Аккумуляторы могут вызвать опасность поражения электрическим током или ожога от тока короткого замыкания. Соблюдайте соответствующие меры предосторожности.
- Необходимо соблюдать правила утилизации аккумуляторов. Обратитесь к местным нормативным актам за информацией о требованиях к утилизации.
- Никогда не бросайте аккумуляторы в огонь. Аккумуляторы могут взорваться под воздействием огня.

Advertencias de Seguridad

INSTRUCCIONES DE SEGURIDAD IMPORTANTES GUARDE ESTAS INSTRUCCIONES ESTE MANUAL CONTIENE INSTRUCCIONES DE SEGURIDAD IMPORTANTES

PELIGRO



Este SIE contiene VOLTAJES MORTALES. Todas las reparaciones y el servicio técnico deben ser efectuados SOLAMENTE POR PERSONAL DE SERVICIO TÉCNICO AUTORIZADO. No hay NINGUNA PARTE QUE EL USUARIO PUEDA REPARAR dentro del SIE.

ADVERTENCIA



- Este SIE contiene su propia fuente de energía (las baterías). Los receptáculos de salida pueden transmitir corriente eléctrica aun cuando el SIE no esté conectado a un suministro de corriente alterna (c.a.).
- No retire o desenchufe el cable de entrada mientras el SIE se encuentre encendido. Esto suprime la descarga a tierra de seguridad del SIE y de los equipos conectados al SIE.
- Para reducir el riesgo de incendio o de choque eléctrico, instale este SIE en un lugar cubierto, con temperatura y humedad controladas, libre de contaminantes conductores. La temperatura ambiente no debe exceder los 40°C. No trabaje cerca del agua o con humedad excesiva (95% máximo).
- Para los sistemas UPS con salidas cableadas permanentemente, la protección contra exceso de corriente para el/los circuito(s) de CA de salida será suministrada por terceros.
- Para los sistemas UPS con salidas cableadas permanentemente, los interruptores de desconexión debidamente clasificados para el/los circuito(s) de CA de salida serán suministrados por terceros.

PRECAUCIÓN



- Las baterías pueden presentar un riesgo de descargas eléctricas o de quemaduras debido a la alta corriente de cortocircuito. Preste atención a las instrucciones correspondientes.
- Es necesario desechar las baterías de un modo adecuado. Consulte las normas locales para conocer los requisitos pertinentes.
- Nunca deseche las baterías en el fuego. Las baterías pueden explotar si se las expone a la llama.

Säkerhetsföreskrifter

VIKTIGA SÄKERHETSFÖRESKRIFTER SPARA DESSA FÖRESKRIFTER DENNA BRUKSANVISNING INNEHÅLLER VIKTIGA SÄKERHETSFÖRESKRIFTER



FARA

Denna UPS-enhet innehåller LIVSFARLIG SPÄNNING. ENDAST AUKTORISERAD SERVICEPERSONAL får utföra reparationer eller service. Det finns inga delar som ANVÄNDAREN KAN UTFÖRA SERVICE PÅ inuti UPS-enheten.



VARNING

- Denna UPS-enhet har en egen energikälla (batterier). De utgående kontakterna kan vara strömförande när UPS-enheten inte är ansluten till en växelströmkälla.
- Ta aldrig bort nätsladden när UPS-enheten är påslagen. Detta tar bort skyddsjordningen från både UPS-enheten och den anslutna utrustningen.
- Minska risken för brand eller elektriska stötar genom att installera denna UPS-enhet inomhus, där temperatur och luftfuktighet är kontrollerade och där inga ledande föroreningar förekommer. Omgivande temperatur får ej överstiga 40°C. Använd inte utrustningen nära vatten eller vid hög luftfuktighet (max 95 %).
- Överströmsskydd för de utgående växelströmskretsarna ska tillhandahållas av andra för UPS-system med fasta utgångar.
- Bortkopplingswitchar med passande dimensionering för de utgående växelströmskretsarna ska tillhandahållas av andra för UPS-system med fasta utgångar.



VIKTIGT

- Batterierna kan ge elektriska stötar eller brännskador från hög kortslutningsström. Följ tillämpliga anvisningar.
- Batterierna måste avyttras enligt anvisningarna i lokal lagstiftning.
- Använda batterier får aldrig brännas upp. De kan explodera.

Chapter 3 Installation

This section explains:

- Equipment inspection
- UPS setup and installation
- Extended Battery Module (EBM) installation
- Remote emergency power-off (REPO) installation

Inspecting the Equipment

If any equipment has been damaged during shipment, keep the shipping cartons and packing materials for the carrier or place of purchase and file a claim for shipping damage. If you discover damage after acceptance, file a claim for concealed damage.

To file a claim for shipping damage or concealed damage: 1) File with the carrier within 15 days of receipt of the equipment; 2) Send a copy of the damage claim within 15 days to your service representative.



NOTE Check the battery recharge date on the shipping carton label. If the date has expired and the batteries were never recharged, do not use the UPS. Contact your service representative.

NOTE Inspect the battery trays for any loose connections. If any damage occurred during shipment, file a shipping claim as stated above.

UPS Setup

The Powerware 9125 UPS is designed for flexible configurations and can be installed in a rack or as a standalone cabinet.

For rack-mounted installations, follow the instructions with the rail kit before installing the internal batteries.

For standalone installations, continue to “Installing the UPS Internal Batteries” on page 16 to begin the UPS setup.

Installing the UPS Internal Batteries

CAUTION



The UPS battery trays are heavy (28.1 kg/62 lb). A minimum of two people are required to lift the battery trays into the UPS chassis.



NOTE For rack-mounted installations, follow the instructions with the rail kit before installing the internal batteries.

To install the battery trays into the UPS chassis:

1. Verify that the battery circuit breaker on the UPS rear panel is in the OFF position (see Figure 9 on page 20).
2. Slide the battery trays into the chassis (see Figure 2).

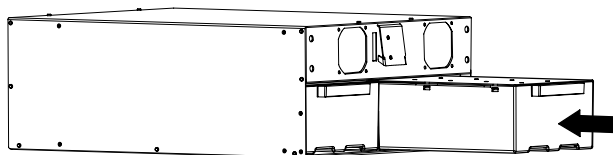

Figure 2. Installing the Battery Trays

3. Secure the battery trays to the chassis with the battery retaining bracket and screws provided in the accessory kit (see Figure 3).

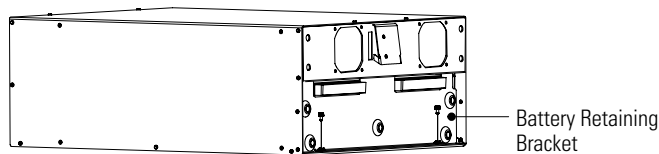

Figure 3. Securing the Battery Trays

4. Install the UPS front covers (provided in the accessory kit). See Figure 4.

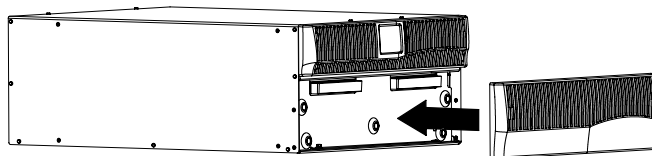

Figure 4. Installing the UPS Front Covers

5. If you are installing the UPS in a tower configuration, continue to the following section, "Tower Setup."

If the UPS is in a rack and you are installing an optional EBM, continue to "EBM Installation" on page 19; otherwise, continue to "Plug-Receptacle UPS Installation" on page 21 or "Hardwired UPS Installation" on page 24.

Tower Setup

The UPS and any optional cabinets must be stabilized with pedestals or joining brackets. The setup varies depending on the number of cabinets you are installing:

1. **For one cabinet,** the pedestals must be installed (purchased separately). Complete Steps 2 through 4.
For two or more cabinets, the pedestals are not installed. Skip to Step 5 to install the supplied joining brackets.
2. Place the UPS horizontally so that the left end of the cabinet is accessible (see Figure 5).
3. Align the UPS pedestals over the holes on the end of the UPS as shown in Figure 5. Secure the pedestals with the supplied screws.

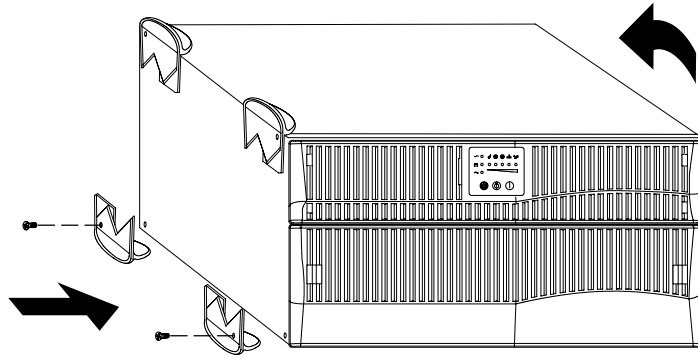

Figure 5. Installing the UPS Pedestals

4. Carefully position the cabinet upright (see Figure 6).

Continue to "Plug-Receptacle UPS Installation" on page 21 or "Hardwired UPS Installation" on page 24.

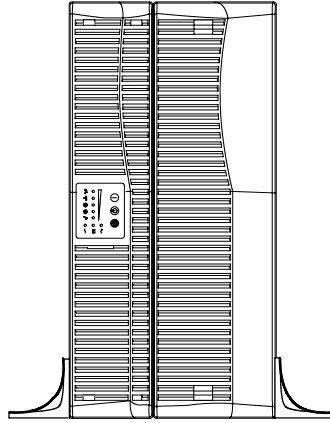

Figure 6. UPS Cabinet with Pedestals

5. Carefully position the cabinets upright (see Figure 7).



NOTE The EBM(s) must be installed to the right of the UPS as shown in Figure 7. Joining brackets are required for installations with two or more cabinets.

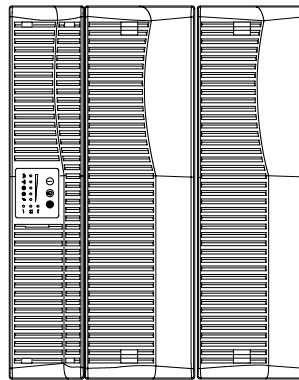

Figure 7. Tower UPS with an EBM

6. Align each joining bracket with the adjacent cabinet screw holes and secure with the supplied screws (see Figure 8).
7. If installing additional cabinets, repeat Step 6 for each cabinet.

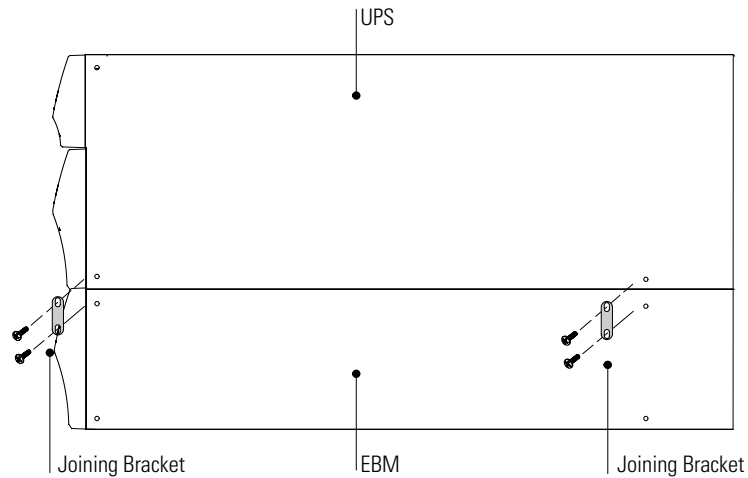

Figure 8. Installing the Joining Brackets (Top View)

8. Continue to the following section, "EBM Installation."

EBM Installation



CAUTION

A small amount of arcing may occur when connecting an EBM to the UPS. This is normal and will not harm personnel. Insert the EBM cable into the UPS battery connector quickly and firmly.

To install the optional EBM(s):

1. Verify that all battery circuit breakers are in the OFF (O) position (see Figure 9).
2. Plug the EBM cable of the first EBM into the UPS battery connector.

If additional EBMs are to be installed, plug the EBM cable of the second cabinet into the battery connector on the first EBM. Repeat for each additional EBM. Up to four EBMs may be connected to the UPS.

3. Continue to the following section, "Plug-Receptacle UPS Installation," or "Hardwired UPS Installation" on page 24.

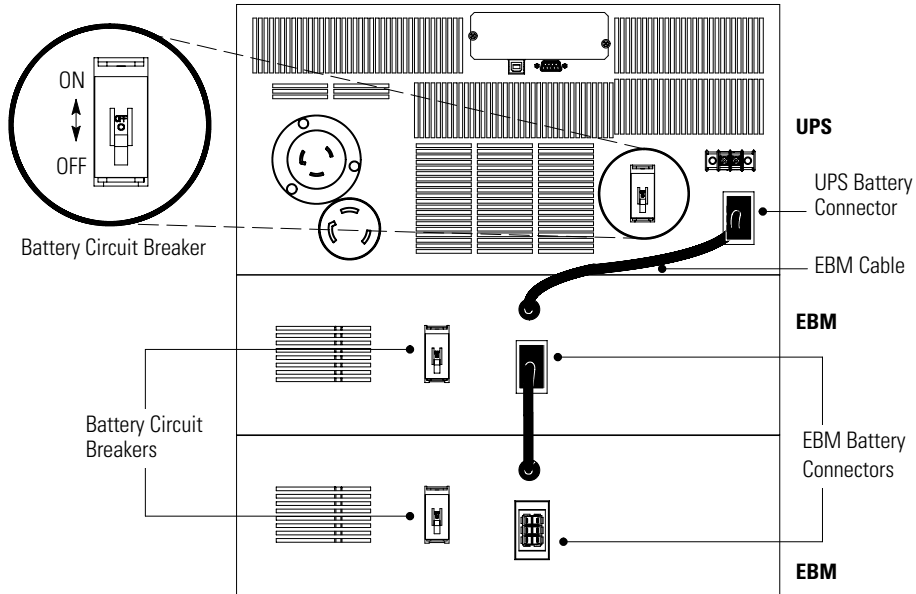

Figure 9. Typical EBM Installation

Plug-Receptacle UPS Installation



NOTE Do not make unauthorized changes to the UPS; otherwise, damage may occur to your equipment and void your warranty.

To install the UPS:

1. If you are installing power management software, connect your computer to the USB port or UPS communication port (see page 37). For the communication port, use only the serial cable supplied in the accessory kit.

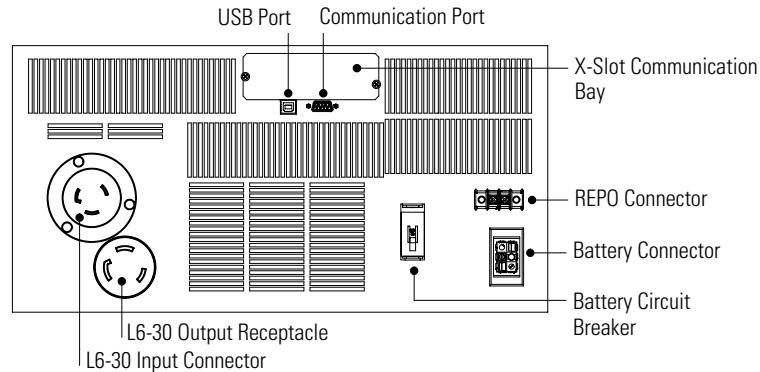

Figure 10. Plug-Receptacle UPS Rear Panel

2. Plug the equipment to be protected into the UPS output receptacle.



NOTE DO NOT protect laser printers with the UPS because of the exceptionally high power requirements of the heating elements.

3. Remove the breaker tie from all battery circuit breakers.
4. Switch all battery circuit breakers to the ON (|) position.
5. Plug the detachable UPS power cord into the input connector on the UPS rear panel.
6. If an emergency power-off (disconnect) switch is required by local codes, see "Remote Emergency Power-off Installation" on page 22 to install the REPO switch before powering on the UPS.

7. Plug the UPS power cord into an L6-30R power outlet.

The ~ indicator flashes, indicating the UPS is in Standby mode with the equipment offline.

8. Press the On | button (see Figure 14 on page 31).

The ~ indicator illuminates solid and the bar graph indicators display the percentage of load being applied to the UPS. The UPS is now in Normal mode and supplying power to your equipment.

The UPS automatically sets the output voltage based on the input voltage. To change the output voltage, see “Configuration” on page 35.



NOTE The batteries charge to 80% capacity in less than 2 hours. However, it is recommended that the batteries charge for 24 hours after installation or long-term storage.

NOTE If you installed power management software and optional EBMs, ensure maximum battery runtime by using the Virtual Front Panel UPS utility on the Software Suite CD.

Remote Emergency Power-off Installation

The Powerware 9125 includes a REPO connector that allows power to be switched off at the UPS output from a customer-supplied switch in a remote location.

The REPO feature shuts down the protected equipment immediately and does not follow the orderly shutdown procedure initiated by any power management software.

Any devices that are operating on battery power are also shut down immediately. When the REPO switch is reset, the equipment will not return to battery power until the UPS is manually restarted.

If the Off  button is pressed after the REPO is activated, the UPS remains in Standby mode when restarted until the On | button is pressed.

WARNING

The REPO circuit is an IEC 60950 safety extra low voltage (SELV) circuit. This circuit must be separated from any hazardous voltage circuits by reinforced insulation.

CAUTION

To ensure the UPS stops supplying power to the load during any mode of operation, the input power must be disconnected from the UPS when the emergency power-off function is activated.



NOTE The REPO function activates when the REPO contacts close.

To install the REPO switch:

1. Verify that the UPS is off and unplugged or removed from utility power.
2. Connect the switch or circuit to the REPO connector on the UPS rear panel using insulated 0.75 mm²–0.5 mm² (18–20 AWG) wire. See Figure 11.



NOTE A separate contact must simultaneously cause UPS input AC power to be removed.

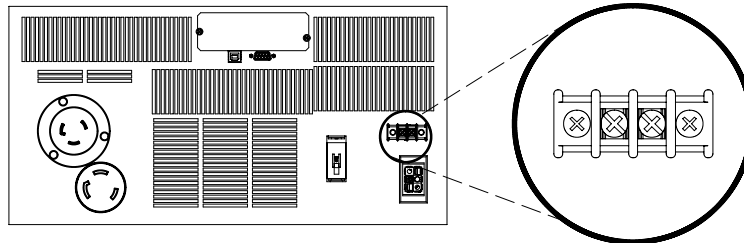

Figure 11. REPO Connector

3. Verify that the externally-connected REPO switch is not activated to enable power to the UPS output receptacle.
4. Plug in or apply utility power to the UPS and start the UPS by pressing the On | button.
5. Activate the external REPO switch to test the REPO function.
6. De-activate the external REPO switch and restart the UPS.

Hardwired UPS Installation

WARNING



Only qualified service personnel (such as a licensed electrician) shall perform the electrical installation. Risk of electrical shock.

CAUTION



- For UPS models with hardwired outputs, overcurrent protection for the output AC circuit(s) is to be provided by others.
 - For UPS models with hardwired outputs, suitably rated disconnect switches for the output AC circuit(s) are to be provided by others.
-



NOTE *Do not make unauthorized changes to the UPS; otherwise, damage may occur to your equipment and void your warranty.*

The Powerware 9125 hardwired models require a dedicated branch circuit that meets the following requirements:

- 40A minimum circuit with short circuit and overcurrent protection
- 200–240 Vac
- Single-phase
- 50/60 Hz
- The breaker must be wall-mounted and be readily accessible to the operator
- Flexible metal conduit (recommended for ease of service and maintenance)

To hardwire the UPS:

1. If you are installing power management software, connect your computer to the USB port or UPS communication port (see page 37). For the communication port, use only the serial cable supplied in the accessory kit.
2. Switch off utility power at the distribution point where the UPS will be connected. Be absolutely sure there is no power.
3. Remove the wiring access cover and the conduit landing plate and retain (see Figure 12).

Punch holes in the conduit landing plate for the input and output conduit using a Greenlee® punch or similar device.

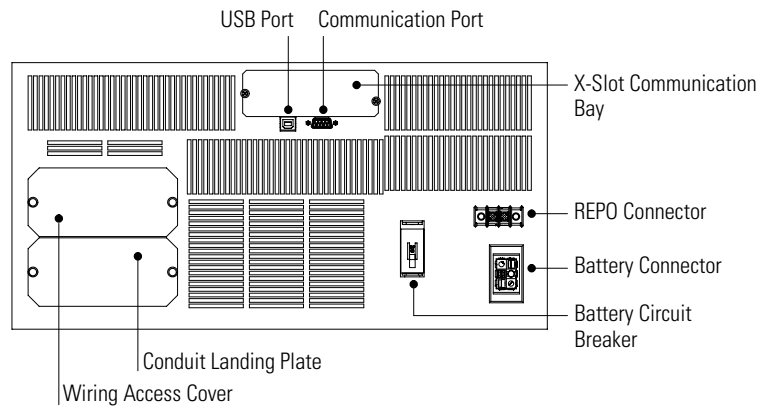

Figure 12. Hardwired UPS Rear Panel

4. Pull the input and output wires through separate conduit, leaving approximately 0.5m (2 ft) of exposed wire. Attach a flexible metal fitting to the end of each conduit.
5. Insert each conduit through a wiring access entry and attach the conduit fitting to the panel. Strip 1.5 cm (0.5") of insulation from the end of each incoming wire.

6. Connect the input and ground wires to the UPS terminal block according to Figure 13 and Table 1.
7. Connect the output and ground wires to the UPS terminal block according to Figure 13 and Table 1.

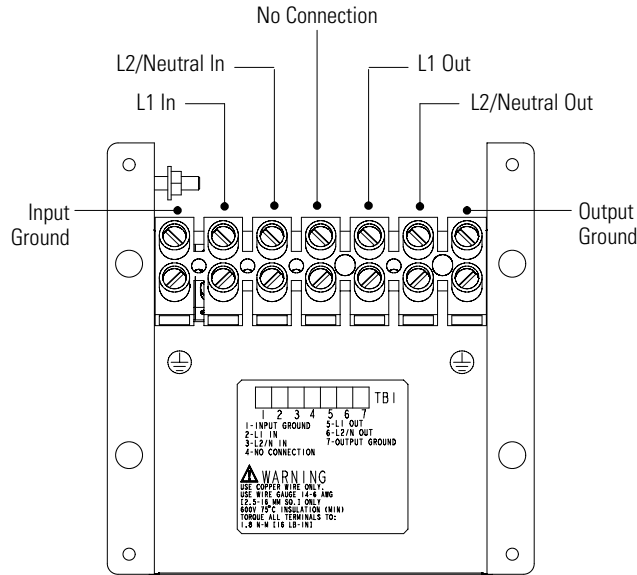

Figure 13. UPS Terminal Block

Table 1. UPS Wiring Specifications

UPS Terminal Block	Terminal Position	UPS Wire Function	Terminal Wire Size Rating*	Tightening Torque
Input	1	Input Ground		
	2	L1 In	2.5–16 mm ² (14–6 AWG)	1.8 Nm (16 lb in)
	3	L2/Neutral In		
No Connection	4	No Connection	—	—
Output	5	L1 Out	2.5–16 mm ² (14–6 AWG)	1.8 Nm (16 lb in)
	6	L2/Neutral Out		
		7	Output Ground	

* Use 2.0 mm² (14 AWG) 75°C copper wire minimum.

8. Replace the wiring access cover and the conduit landing plate.
9. Remove the breaker tie from all battery circuit breakers.
10. Switch all battery circuit breakers to the ON (|) position.
11. If an emergency power-off (disconnect) switch is required by local codes, see "Remote Emergency Power-off Installation" on page 22 to install the REPO switch before powering on the UPS.
12. Switch the main utility breaker on.

The ~ indicator flashes, indicating the UPS is in Standby mode with the equipment offline.

13. Press the On | button (see Figure 14 on page 31).

The ~ indicator illuminates solid and the bar graph indicators display the percentage of load being applied to the UPS. The UPS is now in Normal mode and supplying power to your equipment.

The UPS automatically sets the output voltage based on the input voltage. To change the output voltage, see "Configuration" on page 35.



NOTE *The batteries charge to 80% capacity in less than 2 hours. However, it is recommended that the batteries charge for 24 hours after installation or long-term storage.*

NOTE *If you installed power management software and optional EBMs, ensure maximum battery runtime by using the Virtual Front Panel UPS utility on the Software Suite CD.*

Chapter 4 Operation

This section describes:

- Turning the UPS on and off
- Starting the UPS on battery
- Initiating the battery test
- Transferring the UPS to Bypass mode
- Operating modes

Turning the UPS On

After the UPS is connected to utility power, it enters Standby mode.

To turn on the UPS, press the On | button on the front panel (shown in Figure 14 on page 31). The ~ indicator illuminates solid and the bar graph indicators display the percentage of load being applied to the UPS.

Starting the UPS on Battery



NOTE *Before using this feature, the UPS must have been powered by utility power at least once.*



To turn on the UPS without using utility power, press and hold the On | button for approximately three seconds. The UPS supplies power to your equipment and goes into Battery mode.

Turning the UPS Off



NOTE Pressing the Off  button while the UPS is in Battery mode causes the UPS to shut down immediately.

To turn off the UPS:

1. Prepare your equipment for shutdown.
2. Press and hold the Off  button for approximately three seconds. The  indicator begins to flash. The UPS switches to Standby mode (if utility power is available) and removes power from your equipment.
3. Unplug or remove utility power from the UPS; the UPS shuts down in five seconds. The bar graph and battery indicators flash briefly prior to shutdown.

If you do not unplug or remove utility power from the UPS, it remains in Standby mode.

Initiating the Battery Test



NOTE The batteries must be fully charged and the UPS must not be in Battery mode to perform the battery test.

NOTE For an accurate battery test, test the UPS with at least 50% load applied to the UPS.

The UPS automatically performs a battery test every 30 days. If the UPS switches to Battery mode, the UPS resets the timer.

To initiate a battery test, press and hold the  button for three seconds. The UPS cycles the bar graph indicators twice, verifies the battery converter, and schedules the battery test to occur within 24 hours.

Transferring the UPS to Bypass Mode



NOTE When the UPS is in Bypass mode, Battery mode is not available and the UPS does not protect against power outages; however, the utility power continues to be passively filtered by the UPS.

Press the On | button for approximately eight seconds to transfer the UPS to Bypass mode. The ~> indicator illuminates.

Press the On | button again for approximately three seconds to return to Normal mode.

Operating Modes

Powerware 9125's front panel indicates the UPS status through the UPS indicators. Figure 14 shows the UPS front panel indicators and controls.

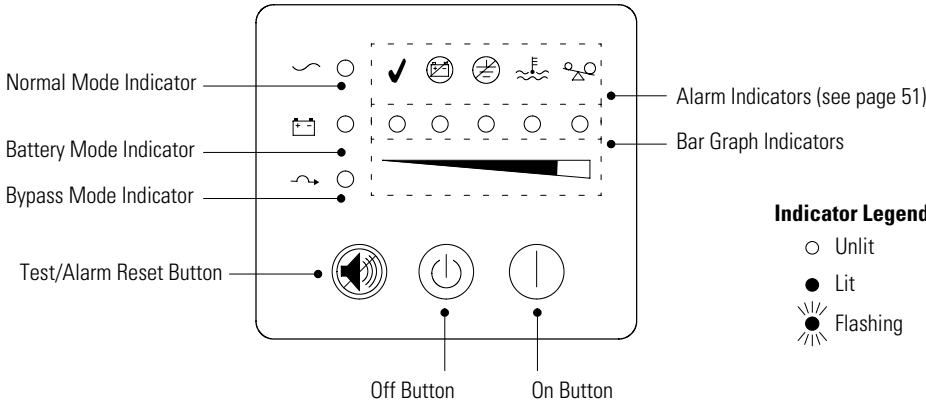

Figure 14. UPS Front Panel

Normal Mode

During Normal mode, the \sim indicator illuminates and the front panel displays the percentage of UPS load capacity being used by the protected equipment (see Figure 15). The UPS monitors and charges the batteries as needed and provides power protection to your equipment.

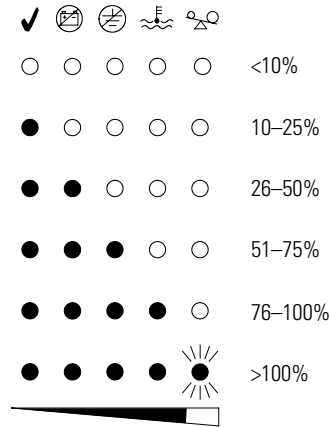



Figure 15. Load Level Indicators

When all of the bar graph indicators are illuminated and the \sim indicator flashes, power requirements exceed UPS capacity; see page 53 for more information.

Battery Mode

When the UPS is operating during a power outage, the alarm beeps once per second and the  indicator illuminates. The front panel displays the approximate percentage of battery capacity remaining (see Figure 16).

When the utility power returns, the UPS switches to Normal mode operation while the battery recharges.

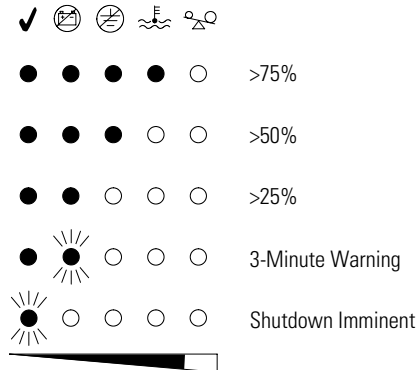



Figure 16. Battery Capacity Indicators

If battery capacity becomes low while in Battery mode, the  indicator flashes and the alarm sounds continuously, indicating approximately three minutes of battery time remaining. When shutdown is imminent, the  indicator flashes.



NOTE Depending on the UPS load, the 3-minute warning may occur before the batteries reach 25% capacity; the front panel immediately displays the 3-minute warning. For UPS and Extended Battery Module (EBM) runtimes, see Table 10 on page 49.

These warnings are approximate, and the actual time to shutdown may vary significantly. Once these warnings are indicated, immediately complete and save your work to prevent data loss and similar difficulties.

When utility power is restored after the UPS shuts down, the UPS automatically restarts.

Bypass Mode

In the event of a UPS overload or internal failure, the UPS transfers your equipment to utility power. Battery mode is not available; however, the utility power continues to be passively filtered by the UPS. The  indicator illuminates. The UPS switches to Bypass mode when:

- The UPS has an overtemperature condition.
- The UPS has an overload condition of 103 to 112% for 2 minutes.
- The UPS has an overload condition of 112 to 150% for up to 30 seconds.
- The UPS detects a fault in the UPS electronics.
- The UPS has been transferred to Bypass mode through the front panel (see page 31).



NOTE *If the UPS electronics fail, the UPS provides surge-protected utility power; frequency conversion (FC) UPS models no longer convert the utility frequency to the load.*

Standby Mode

When the UPS is turned off and remains plugged into a power outlet, the UPS is in Standby mode. The  indicator flashes and the bar graph indicators are off, indicating that power is not available to your equipment. The battery recharges when necessary.



NOTE *For 208–240V models, the output receptacles may remain electrically live (up to 110–120V). Unplug the UPS to ensure power is not available to the output receptacles.*

Chapter 5 Configuration



When the UPS is in Configuration mode, the bar graph indicators represent the configuration options. Use the control buttons (On | button and  button) to modify the UPS configuration. Figure 17 shows the LEDs and Table 2 explains the corresponding options.



NOTE *The UPS can be configured while in Battery mode.*



CAUTION

DO NOT press the Off  button while the UPS is in Configuration mode; pressing the Off  button removes all power to your equipment immediately and the UPS enters Standby mode.

To reconfigure the UPS default settings:

1. Press and hold the On | button and the  button simultaneously for three seconds. The UPS switches to Configuration mode.

The bar graph indicators flash briefly and then display the enabled options.

2. Press and hold the On | button until you hear the second beep to scroll through the options. The LED for the selected option indicates the current setting; flashing represents disabled options (see Figure 17 and Table 2).

Scrolling past the last LED returns to the first configuration option.

If you press the On | button and nothing happens, the UPS is still in Operation mode. Repeat Step 1 to enter Configuration mode, and then perform Step 2.

3. Press the  button ONCE to select the Voltage option or to toggle the Site Wiring Fault Alarm on or off.



NOTE *The UPS exits Configuration mode automatically after two minutes of inactivity.*

4. Press and hold the On | button and the  button simultaneously for three seconds to exit Configuration mode at any time.

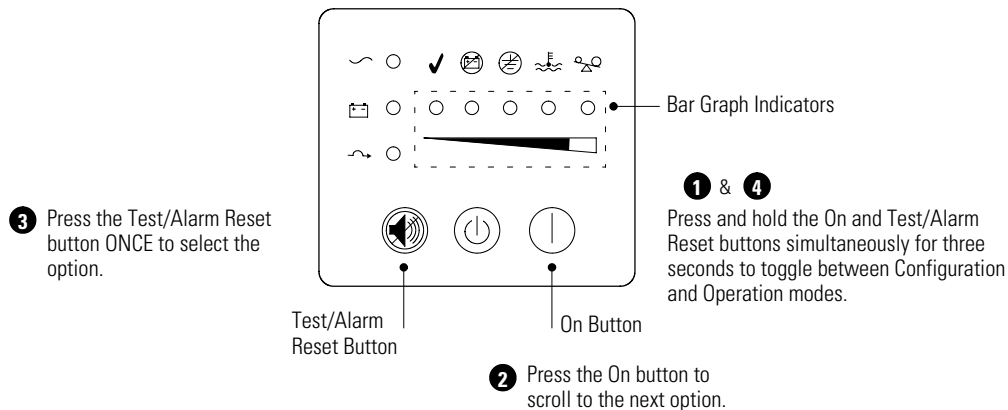

Figure 17. Using Configuration Mode

Table 2. Configuration Mode LEDs and Options

Bar Graph Indicators	Option	LED Status	Explanation
	240V Nominal Output Voltage	On	Nominal output voltage is 240V. All other nominal output voltages are disabled.
		Flashing	240V is disabled; one of the other output voltage options is selected.
	230V Nominal Output Voltage	On	Nominal output voltage is 230V. All other nominal output voltages are disabled.
		Flashing	230V is disabled; one of the other output voltage options is selected.
	220V Nominal Output Voltage	On	Nominal output voltage is 220V. All other nominal output voltages are disabled.
		Flashing	220V is disabled; one of the other output voltage options is selected.
	208V Nominal Output Voltage	On	Nominal output voltage is 208V. All other nominal output voltages are disabled.
		Flashing	208V is disabled; one of the other output voltage options is selected.
	Site Wiring Fault Alarm	On	Alarm sounds when the polarity of the outlet is reversed or the ground connection is missing; have a qualified electrician repair the outlet wiring.
		Flashing (default)	Alarm DOES NOT sound when the polarity of the outlet is reversed or the ground connection is missing.

Chapter 6 Communication

The Powerware 9125 UPS is equipped with a USB port, a DB-9 communication port, and an X-Slot communication bay (see Figure 18).

Either the USB port or the DB-9 communication port may be used to monitor the UPS; however, they cannot operate simultaneously.

The X-Slot communication bay can accommodate any Powerware X-Slot card and can operate simultaneously with the USB port or DB-9 communication port.

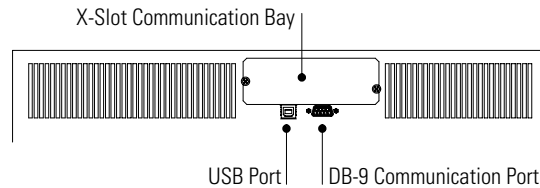

Figure 18. Communication Options

USB Port

The UPS can communicate with a USB-compliant computer using Powerware LanSafe™ Power Management Software (v5.0.1 or higher).

To establish communication between the UPS and a computer:

1. Connect the USB cable to the USB port on the UPS rear panel (see Figure 18).

Connect the other end of the USB cable to the USB port on your computer.

2. Install the Powerware LanSafe software and USB drivers according to the instructions provided with the Software Suite CD.

DB-9 Communication Port

To establish communication between the UPS and a computer, connect your computer to the UPS communication port using the supplied communication cable (see Figure 18).

When the communication cable is installed, power management software can exchange data with the UPS. The software polls the UPS for detailed information on the status of the power environment. If a power emergency occurs, the software initiates the saving of all data and an orderly shutdown of the equipment.

The cable pins are identified in Figure 19 and the pin functions are described in Table 3.

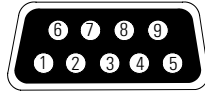

Figure 19. Communication Port

Table 3. Communication Port Pin Assignment

Pin Number	Signal Name	Function	Direction from the UPS
1	Low Batt	Low Battery relay contact; 20 mA, 30 Vdc contact rating	Out
2	TxD	Transmit to external device	Out
3	RxD	Receive from external device	In
4	DTR	PnP (Plug and Play) from external device (tied to Pin 6)	In
5	GND	Signal common (tied to chassis)	—
6	DSR	To external device (tied to Pin 4)	Out
7	—	No Connection	—
8	AC Fail	AC Fail relay contact; 20 mA, 30 Vdc contact rating	Out
9	Power Source	+V (8 to 24 volts DC power)	Out

X-Slot Cards

X-Slot cards allow the UPS to communicate in a variety of networking environments and with different types of devices. The Powerware 9125 has an available communication bay for one of the following X-Slot cards:

- ConnectUPS™-X Web/SNMP Card - has SNMP and HTTP capabilities as well as monitoring through a Web browser interface; connects to a twisted-pair Ethernet (10/100BaseT) network. It has a built-in switching hub that allows three additional network devices to be connected to the network without the requirement of additional network drops. In addition, a Powerware Environmental Monitoring Probe can be attached to obtain humidity, temperature, smoke alarm, and security information.
- Relay Interface Card - has isolated dry contact (Form-C) relay outputs for UPS status: Utility failure, Low battery, UPS alarm/OK, or On bypass.
- Modbus® Card - allows you to continuously and reliably monitor the UPSs in your Building Management System (BMS).
- Multi-Server Card - has six serial communication ports that can communicate simultaneously with other computers using Powerware LanSafe Power Management Software (provided on the Software Suite CD).
- USB Card - connects to a USB port on your computer.

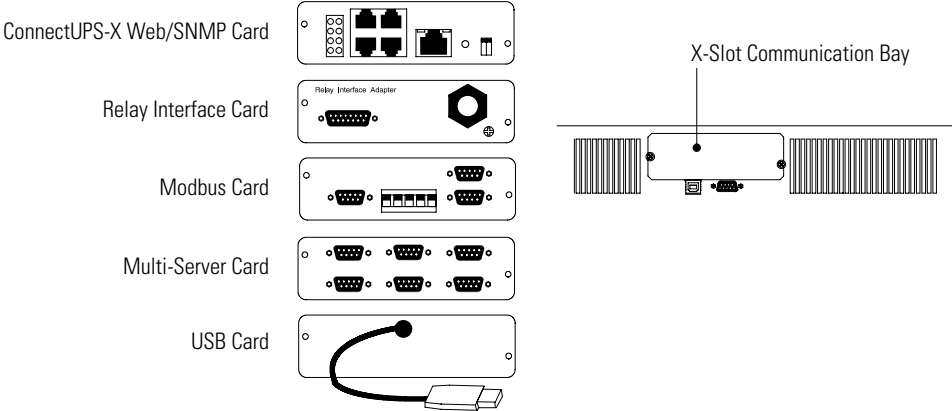

Figure 20. Optional X-Slot Cards

Chapter 7 UPS Maintenance

This section explains how to:

- Care for the UPS and batteries
- Replace the batteries
- Test new batteries
- Recycle used batteries or UPS

UPS and Battery Care

For the best preventive maintenance, keep the area around the UPS clean and dust-free. If the atmosphere is very dusty, clean the outside of the system with a vacuum cleaner.

For full battery life, keep the UPS at an ambient temperature of 25°C (77°F).



NOTE *If the UPS requires any type of transportation, verify that the battery circuit breaker on the UPS rear panel is in the OFF (O) position (see Figure 9 on page 20).*

NOTE *The batteries in the UPS are rated for a 3–5 year service life. The length of service life varies, depending on the frequency of usage and ambient temperature. Batteries used beyond expected service life will often have severely reduced runtimes. Replace batteries at least every 5 years to keep units running at peak efficiency.*

Storing the UPS and Batteries

If you store the UPS for a long period, recharge the battery every 10 months by connecting the UPS to utility power. The batteries charge to 80% capacity in less than 2 hours. However, it is recommended that the batteries charge for 24 hours after long-term storage.

Check the battery recharge date on the shipping carton label. If the date has expired and the batteries were never recharged, do not use the UPS. Contact your service representative.

When to Replace Batteries

When the indicator flashes, the batteries may need replacing. Contact your service representative to order new batteries.

Replacing Batteries



NOTE *DO NOT DISCONNECT the batteries while the UPS is in Battery mode.*

With the hot-swappable battery feature, UPS batteries can be replaced easily without turning the UPS off or disconnecting the load.

If you prefer to remove input power to change the battery, press and hold the Off  button for approximately three seconds, then unplug or remove utility power from the UPS.

Consider all warnings, cautions, and notes before replacing batteries.

WARNING



- Batteries can present a risk of electrical shock or burn from high short-circuit current. The following precautions should be observed: 1) Remove watches, rings, or other metal objects; 2) Use tools with insulated handles; 3) Do not lay tools or metal parts on top of batteries.
 - **ELECTRIC ENERGY HAZARD.** Do not attempt to alter any battery wiring or connectors. Attempting to alter wiring can cause injury.
-

How to Replace Extended Battery Modules

To replace the EBMs:

1. Switch all battery circuit breakers to the OFF (O) position (see Figure 21).
2. Unplug the EBM cable from the UPS.

If additional EBMs are installed, unplug the EBM cable from the battery connector on each EBM.
3. If the UPS is in a tower configuration, remove the joining brackets.
4. If the UPS is in a rack, attach the supplied mounting brackets to the new EBM.

5. Replace the EBM. See “Recycling the Used Battery or UPS” on page 46 for proper disposal.
6. Reinstall the joining brackets if removed in Step 3.
7. Plug the new EBM into the UPS as shown in Figure 21.

For additional EBMs, plug the EBM cable into the battery connector on the adjacent EBM.

8. Remove the breaker tie from the circuit breaker on all EBMs.
9. Switch all battery circuit breakers to the ON (|) position.

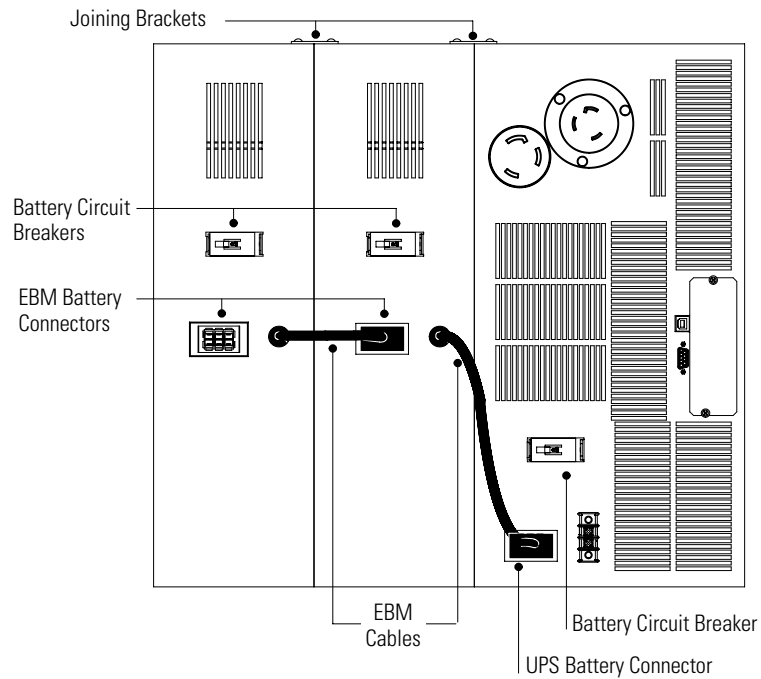

Figure 21. EBM Connections

How to Replace Internal Batteries

CAUTION



- The UPS battery trays are heavy (28.1 kg/62 lb). A minimum of two people are required to lift the battery trays into the UPS chassis.
- Pull the battery trays out onto a flat, stable surface. The battery trays are unsupported when you pull them out of the UPS.

To replace the internal batteries:

1. Switch the battery breaker on the UPS rear panel to the OFF (O) position.
2. Remove the lower UPS front cover (see Figure 22).

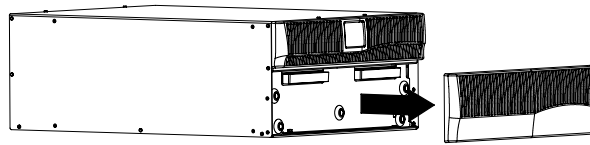

Figure 22. Removing the Lower UPS Front Cover

3. Unscrew and set aside the battery retaining bracket (see Figure 23).

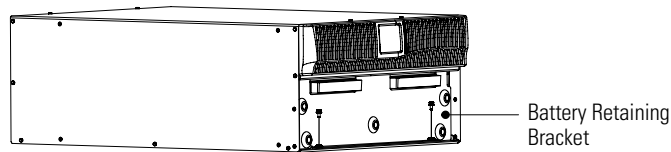

Figure 23. Removing the Battery Retaining Bracket

4. Pull the battery trays out onto a flat, stable surface (see Figure 24). See "Recycling the Used Battery or UPS" on page 46 for proper disposal.

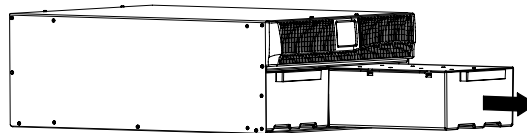

Figure 24. Removing the Battery Trays

5. Slide the new battery trays into the chassis.
6. Reinstall the battery retaining bracket.
7. Replace the lower UPS front cover.

Testing New Batteries



NOTE *The batteries must be fully charged and the UPS must not be in Battery mode to perform the battery test.*

NOTE *For an accurate battery test, test the UPS with at least 50% load applied to the UPS.*

To test the new batteries:

1. Plug the UPS into a power outlet (apply utility power on hardwired models) for 24 hours to charge the battery.
2. After charging the battery, press and hold the  button for three seconds to initiate a battery test.

The UPS cycles the bar graph indicators twice, verifies the battery converter, and schedules the battery test to occur within 24 hours.

Recycling the Used Battery or UPS

Contact your local recycling or hazardous waste center for information on proper disposal of the used battery or UPS.



WARNING

- Do not dispose of the battery or batteries in a fire. Batteries may explode. Proper disposal of batteries is required. Refer to your local codes for disposal requirements.
- Do not open or mutilate the battery or batteries. Released electrolyte is harmful to the skin and eyes. It may be toxic.



CAUTION

Do not discard the UPS or the UPS batteries in the trash. This product contains sealed, lead-acid batteries and must be disposed of properly. For more information, contact your local recycling/reuse or hazardous waste center.



CAUTION

Do not discard waste electrical or electronic equipment (WEEE) in the trash. For proper disposal, contact your local recycling/reuse or hazardous waste center.

Chapter 8 Specifications

This section provides the following specifications:

- Model list
- Electrical input and output
- Environmental and safety
- Weights and dimensions
- Battery

Table 4. Model List

Model Number	Power Levels (Rated at Nominal Inputs)
PW9125 5000g	5000 VA, 3500W
PW9125 5000g HW	
PW9125 5000g FC	
PW9125 5000g HW FC	
PW9125 6000g	6000 VA, 4200W
PW9125 6000g HW	
PW9125 6000g FC	
PW9125 6000g HW FC	

Table 5. Electrical Input

Nominal Voltage	208, 220, 230, 240V auto-sensing
Voltage Range	160–288V nominal
Nominal Frequency	47–63 Hz, 50/60 Hz auto-sensing
Noise Filtering	MOVs and line filter for normal and common mode noise
Connections	L6-30 input connector with detachable power cord or Hardwired
Input Power Factor	>0.96

Table 6. Electrical Output

Regulation (Normal Mode)	Nominal output voltage $\pm 3\%$
Regulation (Battery Mode)	Nominal output voltage $\pm 3\%$
Voltage Waveform	Normal mode: Sine wave; $<3\%$ THD with linear or PFC load; $<6\%$ with nonlinear load or SMPS
Output Receptacles	L6-30R or Hardwired

Table 7. Environmental and Safety

Operating Temperature	0°C to 40°C (32°F to 104°F) Optimal battery performance: 25°C (77°F)
Storage Temperature	0°C to 25°C (32°F to 77°F)
Transit Temperature	-25°C to 55°C (-13°F to 131°F)
Relative Humidity	5–95% noncondensing
Operating Altitude	Up to 3,000 meters above sea level
Transit Altitude	Up to 10,000 meters above sea level
Heat Dissipation	2066 BTU/hr maximum
Audible Noise	Less than 50 dBA Normal mode, typical load Less than 60 dBA Battery mode
Leakage Current	< 0.6 mA
Communication	DB-9: 1200-19200 baud; USB 1.1 compliant
Surge Suppression	ANSI C62.41 Category B3 EN 61000-4-5 Level 3, Criteria B
Safety Conformance	UL 1778; CSA C22.2, No. 107.1, 107.2; EN 50091-1-1 and IEC 60950; NOM-019-SCFI
Agency Markings	cULus, cUL, NOM-NYCE, CE UL/DEMKO GS (hardwired models only)
EMC (Class A)	EN 50091-2, FCC Part 15, ICES-003

Table 8. Weights and Dimensions

	UPS	Extended Battery Module (EBM)
Dimensions (WxDxH)	44.2 x 68.3 x 21.8 cm 17.4" x 26.9" x 8.6" (5U)	44.2 x 68.3 x 13 cm 17.4" x 26.9" x 5.1" (3U)
Weights	UPS Chassis: 35 kg (77 lb) Internal Battery Trays (2): 27.4 kg (60.5 lb) each Total UPS Weight: 89.8 kg (198 lb)	69.9 kg (154 lb)

Table 9. Battery

Configuration	(20) 12V, 7.2 Ah internal batteries
EBM Configuration	PW9125 240 EBM: (20) 12V, 9 Ah
Type	Sealed, maintenance-free, valve-regulated, lead-acid
Charging	Internal battery: less than 2 hours to 80% usable capacity at nominal line voltage after full load discharge External battery: no more than 15x discharge time to 90% usable capacity at nominal line voltage after full load discharge
Monitoring	Advanced monitoring for earlier failure detection and warning

Table 10. Battery Runtimes (in Minutes)

Load	UPS Internal Batteries	1 EBM	2 EBMs	3 EBMs	4 EBMs
6000 VA/4200W	9.7	29.7	52.1	76.3	102
5000 VA/3500W	13.2	37.4	65.3	95.6	127.7
4000 VA/2800W	19.2	49.2	85.8	125.4	167.5
3000 VA/2100W	24.3	70.1	121.9	178.0	237.4
2000 VA/1400W	37.7	107.5	186.2	271.4	361.6

NOTE Battery times are approximate and vary depending on the load configuration and battery charge.

Chapter 9 Troubleshooting

This section explains:

- UPS alarms and conditions
- How to silence an alarm
- Service and support

Audible Alarms and UPS Conditions

The UPS has an audible alarm feature to alert you of potential power problems. Use Table 11 to determine and resolve the UPS alarms and conditions.

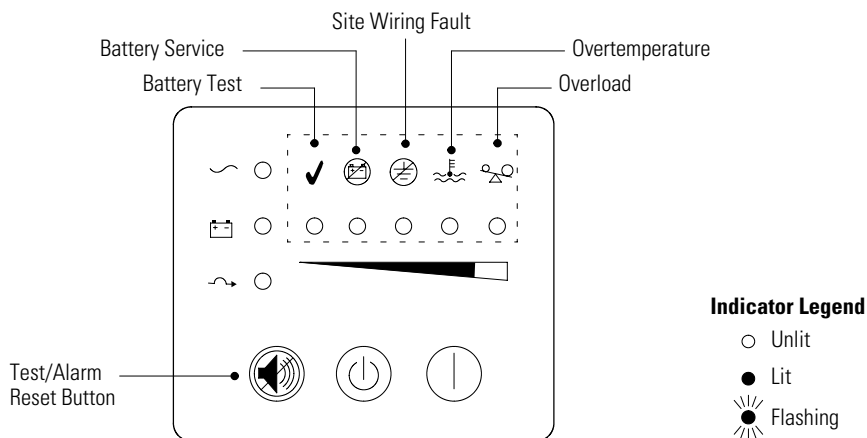

Figure 25. Alarm Indicators

Silencing an Audible Alarm

Before silencing an alarm, check the alarm condition and perform the applicable action to resolve the condition (see Table 11).























To silence the alarm for an existing fault, press the  button. If UPS status changes, the alarm beeps, overriding the previous alarm silencing.

Table 11. Troubleshooting Guide

Alarm or Condition	Possible Cause	Action
The  indicator is not on; the UPS does not start.	The power cord is not connected correctly.	Check the power cord connections.
	The wall outlet is faulty.	Have a qualified electrician test and repair the outlet.
	The main utility breaker is off.	Verify that the main utility breaker is on.
The  indicator is flashing; power is not available to your equipment.	The UPS is in Standby mode.	Press the On button to supply power to the connected equipment.
The UPS operates normally, but some or all of the protected equipment is not on.	The equipment is not connected to the UPS correctly.	Verify that the equipment is plugged into the UPS receptacle. For hardwired models, contact a qualified electrician to check connections to the power source.
The UPS does not provide the expected backup time.	The batteries need charging or service.	Plug the UPS into a power outlet (apply utility power on hardwired models) for 24 hours to charge the battery. After charging the battery, press and hold the  button for 3 seconds; then check the  indicator. If the  indicator is still on, see "UPS Maintenance" on page 41 to replace the battery.
	Battery circuit breakers are in the OFF (O) position.	Switch the battery circuit breaker to the ON () position for all connected battery cabinets.
 ● Battery Intermittent audible alarm	UPS on battery (see "Battery Mode" on page 33 for more information).	The UPS is powering the equipment with battery power. Check the bar graph indicators for available battery capacity and prepare your equipment for shutdown.
  Battery Intermittent audible alarm	The UPS does not detect any batteries.	Verify that the internal batteries are installed correctly (see page 16) and that the battery circuit breaker is in the ON () position.
 ● ●  ○ ○ ○  Warning - Low Battery	Three-minute battery warning.	Three minutes or less of battery power remains (depending on load configuration and battery charge). Prepare for a shutdown. Save your work and turn off your equipment.
 ●  ○ ○ ○ ○ ○  Shutdown - Low Battery	Shutdown imminent.	Prepare equipment for shutdown.

Alarm or Condition	Possible Cause	Action
 Bypass	UPS is in Bypass mode.	The equipment is transferred to utility power; however, the utility power continues to be passively filtered by the UPS. Check for one of the following alarms: Overtemperature, Overload, or UPS Failure. The UPS automatically returns online after the condition is cleared. However, if the UPS transfers to Bypass mode 3 times in 1 hour, the UPS remains in Bypass mode until the UPS On button is pressed or the 1-hour timer expires. NOTE If Bypass mode is due to a UPS failure, frequency conversion (FC) UPS models no longer convert the utility frequency to the load.
 Bypass	Bypass is not available. Input voltage is not within $\pm 12\%$ of nominal or input frequency is not within $\pm 3\%$ of nominal.	The UPS is receiving utility power that may be unstable or in brownout conditions. The UPS continues to supply power to your equipment. If conditions worsen, the UPS may switch to battery power.
 Battery Service	The battery may be fully discharged.	Plug the UPS into a power outlet (apply utility power on hardwired models) for 24 hours to charge the battery. After charging the battery, press and hold the  button for 3 seconds; then check the  indicator. If the  indicator is still on, see "UPS Maintenance" on page 41 to replace the battery.
	The battery is not connected correctly or the battery circuit breaker is open.	Verify that the internal batteries are installed correctly (see page 16) and that the battery circuit breaker is in the ON () position. Call your service representative if the problem persists.
 Site Wiring Fault (North American models only)	Ground wire connection does not exist or the line and neutral wires are reversed in the wall outlet.	Have a qualified electrician correct the wiring. To disable this alarm, see "Configuration" on page 35.
 Overtemperature	UPS internal temperature is too high. The UPS switches to Bypass, allowing the UPS to cool.	Clear vents and remove any heat sources. Ensure the airflow around the UPS is not restricted. If the condition persists, contact your service representative.
 Overload Continuous audible alarm	Power requirements exceed UPS capacity (103–112% for 2 minutes; 112–150% for up to 30 seconds) or the load is defective.	Remove some of the equipment from the UPS. If the overload condition persists, the UPS automatically shuts down.

Service and Support

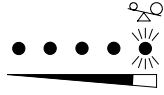
If you have any questions or problems with the UPS, call your **Local Distributor** or the **Help Desk** at one of the following telephone numbers and ask for a UPS technical representative.

United States: **1-800-356-5737** or **1-919-870-3149**
Canada: **1-800-461-9166 ext 260**
All other countries: **Call your local service representative**

Please have the following information ready when you call the Help Desk:

- Model number
- Serial number (located behind the UPS front cover)
- Version number (if available)
- Date of failure or problem
- Symptoms of failure or problem
- Customer return address and contact information

If repair is required, you will be given a Returned Material Authorization (RMA) Number. This number must appear on the outside of the package and on the Bill Of Lading (if applicable). Use the original packaging or request packaging from the Help Desk or distributor. Units damaged in shipment as a result of improper packaging are not covered under warranty. A replacement or repair unit will be shipped, freight prepaid for all warrantied units.



NOTE For critical applications, immediate replacement may be available. Call the **Help Desk** for the dealer or distributor nearest you.

Chapter 10 Warranty

Two-Year Limited Warranty (US and Canada)

Powerware UPS Models: 3105, 3110, 3115, 9104, 9120, 9125, and FERRUPS® up to 3.1 kVA

WARRANTOR: The warrantor for the limited warranties set forth herein is Eaton Power Quality Corporation, a Delaware Corporation company (“Company”).

LIMITED WARRANTY: This limited warranty (this “Warranty”) applies only to the original End-User (the “End-User”) of any Powerware 3105, 3110, 3115, 9104, 9120, 9125, and FERRUPS up to 3.1 kVA Products (individually and collectively, the “Product”) purchased on or after June 1, 2004 and cannot be transferred. This Warranty applies even in the event that the Product is initially sold by Company for resale to an End-User.

LIMITED WARRANTY PERIOD: The period covered by this Warranty for Product installed [and currently located] in the fifty (50) United States, the District of Columbia, and Canada is twenty-four (24) months from the date of purchase.

WHAT THIS LIMITED WARRANTY COVERS: The warrantor warrants that the Product and battery (individually and collectively, the “Warranted Items”) are free from defects in material and workmanship. If, in the opinion of Company, a Warranted Item is defective and the defect is within the terms of this Warranty, Company’s sole obligation will be to repair or replace such defective Warranted Item (including by providing service, parts and labor, as applicable), at the option of Company.

PROCEDURES FOR REPAIR OR REPLACEMENT OF WARRANTED ITEMS: The Warranted Item will be repaired or replaced at a Company site or such other location as determined by Company.

If the Warranted Item is to be replaced by Company, and the End-User supplies a credit card number or purchase order for the value of the replacement Product, Company will use commercially reasonable business efforts to ship (via standard ground shipment and at no cost to the End-User) the replacement Warranted Item to the End-User within one (1) business day after Company receives notice of the warranty claim. In such case, the End-User must return (at Company’s expense) the defective Warranted Item to Company in the same packaging as the replacement Warranted Item received by the End-User or as otherwise instructed by Company. If Company does not receive the defective Warranted Item, Company will either charge the End-User’s credit card, or send the End-User an invoice (which the End-User agrees to pay), for the value of the replacement Product.

If the Warranted Item is to be replaced by Company, but the End-User is unwilling or unable to supply a credit card number or purchase order for the value of the replacement Product, Company will use commercially reasonable business efforts to ship (via standard ground shipment and at no cost to the End-User) the replacement Warranted Item to the End-User within one (1) business day after Company receives the defective Product from the End-User.

In any case, Company will provide shipping instructions and will pay its designated carrier for all shipping charges for return of defective equipment and replacement of Warranted Items. Any returned Warranted Item or parts that are replaced may be new or reconditioned. All Warranted Items returned to Company and all parts replaced by Company shall become the property of Company.

WHAT THIS LIMITED WARRANTY DOES NOT COVER: This Warranty does not cover any defects or damages caused by: (a) failure to properly store the Product before installation, including the charge of batteries no later than the date indicated on the packaging; (b) shipping and delivery of the Product if shipping is FOB Factory; (c) neglect, accident, abuse, misuse, misapplication, or incorrect installation; (d) repair or alteration not authorized in writing by Company personnel or performed by an authorized Company Customer Service Engineer or Agent; (e) improper testing, operation, maintenance, adjustment, or modification of any kind not authorized in writing by Company personnel or performed by an authorized Company Customer Service Engineer or Agent; or (f) use of the Product under other than normal operating conditions or in a manner inconsistent with the Product's labels or instructions.

This Warranty is not valid if the Product's serial numbers have been removed or are illegible. Any Warranted Items repaired or replaced pursuant to this Warranty will be warranted for the remaining portion of the original Warranty subject to all the terms thereof.

Company shall not be responsible for any charges for testing, checking, removal or installation of Warranted Items.

COMPANY DOES NOT WARRANT EQUIPMENT NOT MANUFACTURED BY COMPANY. IF PERMITTED BY THE APPLICABLE MANUFACTURER, COMPANY SHALL PASS THROUGH SUCH MANUFACTURER'S WARRANTIES TO END-USER.

COMPANY DOES NOT WARRANT SOFTWARE, INCLUDING SOFTWARE EMBEDDED IN PRODUCTS, THAT IS NOT CREATED BY COMPANY. WITHOUT LIMITING THE FOREGOING, COMPANY SPECIFICALLY DOES NOT WARRANT SOFTWARE (SUCH AS LINUX) THAT WAS CREATED USING AN "OPEN SOURCE" MODEL OR IS DISTRIBUTED PURSUANT TO AN OPEN SOURCE LICENSE.

THIS WARRANTY IS THE SOLE AND EXCLUSIVE WARRANTY OFFERED BY COMPANY WITH RESPECT TO THE PRODUCTS AND SERVICES AND, EXCEPT FOR SUCH FOREGOING WARRANTY COMPANY DISCLAIMS ALL OTHER WARRANTIES INCLUDING BUT NOT LIMITED TO ANY IMPLIED WARRANTIES OF MERCHANTABILITY, TITLE, NON-INFRINGEMENT, AND FITNESS FOR A PARTICULAR PURPOSE. CORRECTION OF NON-CONFORMITIES IN THE MANNER AND FOR THE PERIOD OF TIME PROVIDED ABOVE SHALL CONSTITUTE COMPANY'S SOLE LIABILITY AND END-USER'S EXCLUSIVE REMEDY FOR FAILURE OF COMPANY TO MEET ITS WARRANTY OBLIGATIONS, WHETHER CLAIMS OF THE END-USER ARE BASED IN CONTRACT, IN TORT (INCLUDING NEGLIGENCE OR STRICT LIABILITY), OR OTHERWISE.

LIMITATION OF LIABILITY: The remedies of the End-User set forth herein are exclusive and are the sole remedies for any failure of Company to comply with its obligations hereunder. In no event shall Company be liable in contract, in tort (including negligence or strict liability) or otherwise for damage to property or equipment other than the Products, including loss of profits or revenue, loss of use of Products, loss of data, cost of capital, claims of customers of the End-User or any special, indirect, incidental or consequential damages whatsoever. The total cumulative liability of Company hereunder whether the claims are based in contract (including indemnity), in tort (including negligence or strict liability) or otherwise, shall not exceed the price of the Product on which such liability is based.

Company shall not be responsible for failure to provide service or parts due to causes beyond Company's reasonable control.

END-USER'S OBLIGATIONS: In order to receive the benefits of this Warranty, the End-User must use the Product in a normal way; follow the Product's user's guide; and protect against further damage to the Product if there is a covered defect.

OTHER LIMITATIONS: Company's obligations under this Warranty are expressly conditioned upon receipt by Company of all payments due to it (including interest charges, if any). During such time as Company has not received payment of any amount due to it for the Product, in accordance with the contract terms under which the Product is sold, Company shall have no obligation under this Warranty. Also during such time, the period of this Warranty shall continue to run and the expiration of this Warranty shall not be extended upon payment of any overdue or unpaid amounts.

COSTS NOT RELATED TO WARRANTY: The End-User shall be invoiced for, and shall pay for, all services not expressly provided for by the terms of this Warranty, including without limitation, site calls involving an inspection that determines no corrective maintenance is required. Any costs for replacement equipment, installation, materials, freight charges, travel expenses or labor of Company representatives outside the terms of this Warranty will be borne by the End-User.

OBTAINING WARRANTY SERVICE: In the USA, call the Customer Reliability Center 7x24 at 800-356-5737. Outside of the USA, call your local Powerware product sales or service representative, or call the Customer Reliability Center in the USA at 919-870-3149. For comments or questions about this Warranty, write to the Customer Quality Representative, 3301 Spring Forest Road, Raleigh, North Carolina 27616 USA.

Ten-Year Pro-Rated Limited Warranty (US and Canada)

Powerware UPS Models: 5115, 5125, 5140, 9104, 9120, 9125, 9155, 9170+, and FERRUPS

WARRANTOR: The warrantor for the limited warranties set forth herein is Eaton Power Quality Corporation, a Delaware Corporation company ("Company").

LIMITED WARRANTY: This pro-rated limited warranty (this "Warranty") applies only to the original End-User (the "End-User") of any Powerware 5115, 5125, 5140, 9104, 9120, 9125, 9155, 9170+, and FERRUPS Products (individually and collectively, the "Product") and cannot be transferred. This Warranty applies even in the event that the Product is initially sold by Company for resale to an End-User.

WHAT THIS WARRANTY COVERS: In addition to the standard Two-Year Limited Warranty covering the applicable Product, the warrantor warrants that the Product will have a service life (defined below) of ten years from the date of purchase (the "Ten-Year Service Life") when used in accordance with the storage, handling, installation, operation and maintenance procedures prescribed in the Product's user's guide. "Service life" means the Product's ability to deliver at least 80% of its original rated backup time.

If Company finds, in its sole discretion, that any Product has not provided the Ten-Year Service Life, Company will, as its sole obligation and the End-User's sole remedy for Company's breach of this warranty, repair or replace the Product, at its option, F.O.B. Company's factory, for a charge, payable by the End-User to Company pro-rated on the following basis:

The End-User will be allowed a credit against Company's list price of equivalent equipment at the time of return of the Product to Company, in proportion to the percentage of Ten-Year Service Life remaining at the time of return of the Product to Company. In calculating the available credit, the remaining portion of the Ten-Year Service Life will be rounded up or down to the nearest whole year. The End-User will assume responsibility to pay the balance of the list price; and Company reserves the right to require payment prior to delivery of the repaired or replacement equipment.

For the avoidance of doubt, Company's responsibilities under this Warranty are as follows:

- Years 1-2 - Product repaired or replaced pursuant to terms of Limited Warranty
- Years 3-10 - Unit Credit (\$) = Current List Price \times $\frac{\text{Years of Unexpired Life}}{10 \text{ Years of Warranted Life}}$

WHAT THIS LIMITED WARRANTY DOES NOT COVER: This Warranty does not cover any defects or damages caused by: (a) failure to properly store the Product before installation, including the charge of batteries no later than the date indicated on the packaging; (b) shipping and delivery of the Product if shipping is FOB Factory; (c) neglect, accident, abuse, misuse, misapplication, or incorrect installation; (d) repair or alteration not authorized in writing by Company personnel or performed by an authorized Company Customer Service Engineer or Agent; (e) improper testing, operation, maintenance, adjustment, or modification of any kind not authorized in writing by Company personnel or performed by an authorized Company Customer Service Engineer or Agent; or (f) use of the Product under other than normal operating conditions or in a manner inconsistent with the Product's labels or instructions.

This Warranty is not valid: (a) unless the End-User returns to Company the Warranty Registration Card within thirty (30) days of purchase; or (b) if the Product's serial numbers have been removed or are illegible. Any Warranted Items repaired or replaced pursuant to this Warranty will be warranted for the remaining portion of the original Warranty subject to all the terms thereof.

Company shall not be responsible for any charges for testing, checking, removal or installation of Warranted Items.

COMPANY DOES NOT WARRANT EQUIPMENT NOT MANUFACTURED BY COMPANY. IF PERMITTED BY THE APPLICABLE MANUFACTURER, COMPANY SHALL PASS THROUGH SUCH MANUFACTURER'S WARRANTIES TO END-USER.

COMPANY DOES NOT WARRANT SOFTWARE, INCLUDING SOFTWARE EMBEDDED IN PRODUCTS, THAT IS NOT CREATED BY COMPANY. WITHOUT LIMITING THE FOREGOING, COMPANY SPECIFICALLY DOES NOT WARRANT SOFTWARE (SUCH AS LINUX) THAT WAS CREATED USING AN "OPEN SOURCE" MODEL OR IS DISTRIBUTED PURSUANT TO AN OPEN SOURCE LICENSE.

THIS WARRANTY IS THE SOLE AND EXCLUSIVE WARRANTY OFFERED BY COMPANY WITH RESPECT TO THE PRODUCTS AND SERVICES AND, EXCEPT FOR SUCH FOREGOING WARRANTY COMPANY DISCLAIMS ALL OTHER WARRANTIES INCLUDING BUT NOT LIMITED TO ANY IMPLIED WARRANTIES OF MERCHANTABILITY, TITLE, NON-INFRINGEMENT, AND FITNESS FOR A PARTICULAR PURPOSE. CORRECTION OF NON-CONFORMITIES IN THE MANNER AND FOR THE PERIOD OF TIME PROVIDED ABOVE SHALL CONSTITUTE COMPANY'S SOLE LIABILITY AND END-USER'S EXCLUSIVE REMEDY FOR FAILURE OF COMPANY TO MEET ITS WARRANTY OBLIGATIONS, WHETHER CLAIMS OF THE END-USER ARE BASED IN CONTRACT, IN TORT (INCLUDING NEGLIGENCE OR STRICT LIABILITY), OR OTHERWISE.

LIMITATION OF LIABILITY: The remedies of the End-User set forth herein are exclusive and are the sole remedies for any failure of Company to comply with its obligations hereunder. In no event shall Company be liable in contract, in tort (including negligence or strict liability) or otherwise for damage to property or equipment other than the Products, including loss of profits or revenue, loss of use of Products, loss of data, cost of capital, claims of customers of the End-User or any special, indirect, incidental or consequential damages whatsoever. The total cumulative liability of Company hereunder whether the claims are based in contract (including indemnity), in tort (including negligence or strict liability) or otherwise, shall not exceed the price of the Product on which such liability is based.

Company shall not be responsible for failure to provide service or parts due to causes beyond Company's reasonable control.

END-USER'S OBLIGATIONS: In order to receive the benefits of this Warranty, the End-User must use the Product in a normal way; follow the Product's operation and maintenance manual; and protect against further damage to the Product if there is a covered defect.

OTHER LIMITATIONS: Company's obligations under this Warranty are expressly conditioned upon receipt by Company of all payments due to it (including interest charges, if any). During such time as Company has not received payment of any amount due to it for the Product, in accordance with the contract terms under which the Product is sold, Company shall have no obligation under this Warranty. Also during such time, the period of this Warranty shall continue to run and the expiration of this Warranty shall not be extended upon payment of any overdue or unpaid amounts.

COSTS NOT RELATED TO WARRANTY: The End-User shall be invoiced for, and shall pay for, all services not expressly provided for by the terms of this Warranty, including without limitation, site calls involving an inspection that determines no corrective maintenance is required. Any costs for replacement equipment, installation, materials, freight charges, travel expenses or labor of Company representatives outside the terms of this Warranty will be borne by the End-User.

OBTAINING WARRANTY SERVICE: In the USA, call the Customer Reliability Center 7x24 at 800-356-5737. Outside of the USA, contact your local Powerware product sales or service representative, or call the Customer Reliability Center in the USA at 919-870-3149. Company will not accept any Product for return, credit or exchange unless expressly authorized by Company in writing and delivered FOB Company factory. For comments or questions about this Warranty, write to the Customer Quality Representative, 3301 Spring Forest Road, Raleigh, North Carolina 27616 USA.

Load Protection Guarantee (US and Canada)

Powerware UPS Models 3105, 3110, 3115, 5110, 5115, 5125, 9120, 9125, 9150, 9155, 9170+, and FERRUPS

GUARANTOR: The Guarantor for the load protection guaranty set forth herein is Eaton Power Quality Corporation, a Delaware Corporation company ("Company").

LIMITED GUARANTY: This load protection guaranty (this "Guaranty") applies only to the original End-User (the "End-User") of any Powerware 3105, 3110, 3115, 5110, 5115, 5125, 9120, 9125, 9150, 9155, 9170+, and FERRUPS Products (individually and collectively, the "Product") and cannot be transferred. This Guaranty applies even in the event that the Product is initially sold by Company for resale to an End-User.

WHAT THIS GUARANTY COVERS: For the lifetime of the Product, Guarantor promises to repair or replace, at Guarantor's option, the equipment (valued up to the limits shown below*) that is damaged by an AC power line surge, spike, or other transient when properly connected to Guarantor's uninterruptible power system ("UPS"). Reimbursement for or restoration of data loss excluded. This Guaranty applies only if all of the following circumstances arise:

1. The UPS is plugged into properly grounded and wired outlets, using no extension cords, adapters, other ground wires or other electrical connectors;
2. The installation of the UPS complies with all applicable electrical and safety codes described by the National Electric Code (NEC);
3. The UPS was used under normal operating conditions and in accordance with all labels and instructions; and
4. The UPS was not damaged by accident (other than AC power line transient), misuse, or abuse.

***Cumulative Limits to be paid by Guarantor under this Load Protection Guaranty:**

- \$25,000 for Powerware UPS Models 3105, 3110, and 3115
- \$150,000 for Powerware UPS Models 5110, 5115, and 5125
- \$250,000 for Powerware UPS Models 9120, 9125, 9150, 9155, 9170+, and FERRUPS products

WHAT THIS GUARANTY DOES NOT COVER: Any reimbursement or repair to End-User's equipment does not include reimbursement for or restoration of any data loss. This Guaranty does not cover any defects or damages caused by: (a) failure to properly store the Product before installation, including the charge of batteries no later than the date indicated on the packaging; (b) shipping and delivery of the Product if shipping is FOB Factory; (c) neglect, accident, abuse, misuse, misapplication, or incorrect installation of Product; (d) repair or alteration of Product not authorized in writing by Company personnel or performed by an authorized Company Customer Service Engineer or Agent; (e) improper testing, operation, maintenance, adjustment, or modification of any kind to the Product not authorized in writing by Company personnel or performed by an authorized Company Customer Service Engineer or Agent; or (f) use of the Product under other than normal operating conditions or in a manner inconsistent with the Product's labels or instructions.

This Guaranty is not valid: (a) unless the End-User returns to Company the Warranty Registration Card within thirty (30) days of purchase; or (b) if the Product's serial numbers have been removed or are illegible.

Company shall not be responsible for any charges for testing, checking, removal or installation of any items.

LIMITATION OF LIABILITY: THE REMEDIES OF THE END-USER SET FORTH HEREIN ARE EXCLUSIVE AND ARE THE SOLE REMEDIES FOR ANY FAILURE OF COMPANY TO COMPLY WITH ITS OBLIGATIONS HEREUNDER. EXCEPT AS OTHERWISE PROVIDED FOR IN THIS GUARANTY, IN NO EVENT SHALL COMPANY BE LIABLE IN CONTRACT, IN TORT (INCLUDING NEGLIGENCE OR STRICT LIABILITY) OR OTHERWISE FOR DAMAGE TO PROPERTY OR EQUIPMENT OTHER THAN THE PRODUCTS, INCLUDING LOSS OF PROFITS OR REVENUE, LOSS OF USE OF PRODUCTS, LOSS OF DATA, COST OF CAPITAL, CLAIMS OF CUSTOMERS OF THE END-USER OR ANY SPECIAL, INDIRECT, INCIDENTAL OR CONSEQUENTIAL DAMAGES WHATSOEVER. THE TOTAL CUMULATIVE LIABILITY OF COMPANY HEREUNDER WHETHER THE CLAIMS ARE BASED IN CONTRACT (INCLUDING INDEMNITY), IN TORT (INCLUDING NEGLIGENCE OR STRICT LIABILITY) OR OTHERWISE, SHALL NOT EXCEED THOSE SET FORTH ABOVE.

Company shall not be responsible for failure to provide repair or replacement under this Guaranty due to causes beyond Company's reasonable control.

END-USER'S OBLIGATIONS: In order to receive the benefits of this Guaranty, the End-User must use the Product in a normal way; follow the Product's operation and maintenance manual; and protect against further damage to the Product if there is a covered defect.

OTHER LIMITATIONS: Company's obligations under this Guaranty are expressly conditioned upon receipt by Company of all payments due to it (including interest charges, if any). During such time as Company has not received payment of any amount due to it for the Product, in accordance with the contract terms under which the Product is sold, Company shall have no obligation under this Guaranty.

COSTS NOT RELATED TO GUARANTY: The End-User shall be invoiced for, and shall pay for, all services not expressly provided for by the terms of this Guaranty, including without limitation, site calls involving an inspection that determines no corrective maintenance is required. Any costs for replacement equipment, installation, materials, freight charges, travel expenses or labor of Company representatives outside the terms of this Guaranty will be borne by the End-User.

TO MAKE A CLAIM: In the USA, call the Customer Reliability Center 7x24 at 800-356-5737. Outside of the USA, contact your local Powerware product sales or service representative, or call the Customer Reliability Center in the USA at 919-870-3149. For comments or questions about this Load Protection Guaranty, write to the Customer Quality Representative, 3301 Spring Forest Road, Raleigh, North Carolina 27616 USA.